



---

# SGS PRIME COGO

---

Version 1.8.1 - Reference Manual



March 1, 2020

<https://sgss.ca/>

# Table of Contents

<b>1</b>	<b>Installation .....</b>	<b>6</b>
1.1	New Installation .....	6
1.2	Upgrade to new Version .....	8
1.3	Running SGS Prime COGO.....	10
1.4	License Key .....	11
<b>2</b>	<b>Main Menu and User Interface .....</b>	<b>12</b>
2.1	Main Menu Screen.....	12
	About Screen.....	14
	Project Manager Shortcut .....	14
	User Settings Shortcut.....	15
	Points Database Shortcut .....	15
2.2	Keyboard .....	16
2.3	Input Forms .....	17
	Copy and Paste .....	17
	Touchscreen keypads.....	18
	Point IDs.....	19
	Point Ranges.....	19
	Directions .....	19
	Angles .....	20
	Distances.....	20
	Coordinates .....	21
	Stations .....	21
	Grades.....	21
	Text .....	21
	Choose Lists.....	22
	Checkboxes.....	22
2.4	Choose Boxes .....	23
2.5	Output Screens.....	23
<b>3</b>	<b>User Settings .....</b>	<b>24</b>
3.1	Angle and Distance Units.....	24
	Angle Unit.....	24
	Angle Precision.....	24
	Direction Reference .....	24
	Distance Unit .....	25
	Distance Precision.....	25
	Secondary Unit.....	25
	Display Secondary Unit .....	25
	Foot Definition .....	25
	Foot Display.....	25
3.2	Coordinates, Stations and Grades .....	26

	Coordinate Display .....	26
	Coordinate Precision .....	26
	Stationing Display .....	26
	Stationing Precision .....	26
	Grade Display .....	26
	Grade Precision .....	26
3.3	Input and Output Scale Factors .....	27
	Input Scale Factor.....	27
	Apply Input Scale Factor.....	27
	Inverse?.....	27
	Output Scale Factor.....	27
	Apply Output Scale Factor .....	27
3.4	Program Options .....	28
	Radius Tolerance.....	28
	Time/Date .....	28
	Auto Exit Time .....	28
	Clipboard Size .....	28
3.5	DXF File Layers .....	28
3.6	Coordinate System .....	29
	Projection .....	29
	Radius Method .....	30
	Earth Radius.....	31
	Vertical System.....	31
	Average Geoid Height .....	31
	User Defined Coordinate Systems.....	31
	User Defined Ellipsoids.....	32
3.7	Terminology Localization .....	32
3.8	Settings Use and Application .....	33
<b>4</b>	<b>COGO Menu.....</b>	<b>34</b>
4.1	Point Traverse 2D.....	34
	Point Traverse - Standard.....	35
	Point Traverse – Angle Right .....	36
	Point Traverse – Plus .....	36
	Curve Traverse.....	40
4.2	Inverse Calculations .....	41
	Inverse Points.....	41
	Inverse Curve .....	45
	Inverse Angle.....	47
	Inverse Point to Line .....	47
	Inverse Point to Curve .....	48
	Inverse Points to Alignment .....	48
4.3	Intersections .....	49
	Bearing-Bearing.....	49

	Bearing-Distance .....	50
	Distance-Distance.....	51
	Distance-Interior Angle .....	52
4.4	Areas / Closures .....	53
	Area by Points .....	53
	Subdivide by Sliding Direction .....	55
	Subdivide by Hinge Point.....	56
	Closures .....	57
	Quick Closure .....	61
4.5	Fit Points .....	65
	Fit to Straight Line.....	65
	Fit to Circular Curve.....	67
	Double Proportion.....	69
	Irregular Boundary Adjustment .....	71
	Grant Boundary Adjustment.....	73
<b>5</b>	<b>Adjust Menu.....</b>	<b>74</b>
5.1	Compass Rule .....	74
	Closed Figure .....	74
	Close to Fixed Point.....	76
5.2	Rotate/Mirror Points.....	78
	Rotate around Base Point.....	78
	Rotate around Origin (0,0) .....	79
	Mirror along Baseline.....	79
5.3	Shift/Average Points .....	80
	Shift by $\Delta X/\Delta Y/\Delta Z$ .....	80
	Shift by Distance/Direction/ $\Delta Z$ .....	81
	Shift by From/To Points .....	81
	Average Points .....	82
5.4	Scale Points.....	83
	Scale from Base Point .....	83
	Scale from Origin (0,0,0).....	83
5.5	Transform Coordinates .....	84
	Helmert Transformation .....	84
	3D to Plan Cross Section.....	87
<b>6</b>	<b>Tools Menu .....</b>	<b>88</b>
6.1	Triangle Solver .....	88
6.2	Horizontal Curves .....	89
	Circular Curve Solver.....	89
	Curve Through Fixed Point .....	93
	Spiral Curve Solver.....	94
6.3	Vertical Curves .....	96
	Grades and Length known.....	97
	Elevations and Length known .....	98
	Fixed Point, VPI and Grades known .....	99

	Fixed Point, BVC and Grades known.....	100
	Intersect Slopes from two known points.....	101
	Solution Screen and Calculations .....	102
6.4	RPN Calculator.....	104
	Main Interface.....	104
	Menus.....	106
	Vector objects.....	107
6.5	Configure Settings .....	107
<b>7</b>	<b>Points Menu.....</b>	<b>108</b>
7.1	Store and Edit Points .....	108
	Point ID.....	108
7.2	Delete Points .....	109
7.3	Renumber Points .....	110
	By Starting Number .....	110
	By Additive Number .....	111
7.4	Plot Points .....	112
	Using Touch .....	112
	Using the Keyboard .....	112
	Using the Menu .....	112
7.5	Import/Export .....	113
	Import Points .....	113
	Export Points .....	114
<b>8</b>	<b>Advanced Menu.....</b>	<b>117</b>
8.1	Alignments.....	117
	Alignment Manager.....	117
	Defining an Alignment.....	118
	Alignment Calculations .....	128
8.2	Leveling .....	131
	Leveling Project Manager .....	131
	Working with a Leveling Project.....	132
8.3	Traverse Plus 3D (BETA) .....	138
	Setup.....	138
	Measure .....	144
	Stake .....	145
	Reference .....	150
	Tools.....	153
	Close .....	153
8.4	Coordinate Converter .....	154
	Grid↔Geodetic↔Cartesian .....	154
	Grid1→Grid2 (Single Point) .....	155
	Grid1→Grid2 (Convert Database).....	156
	Grid↔Ground (Single Point).....	157
	Grid↔Ground (Convert Database) .....	158
8.5	Ellipsoid Calculations.....	159

DIRECT Computation .....	159
INVERSE Computation.....	160
<b>Appendix A.....</b>	<b>161</b>



# 1 Installation

Install the **SGS Prime COGO** application for HP Prime on any of the following devices:

- ▶ Physical HP Prime Graphing Calculators
- ▶ Virtual Calculators for [Windows or Mac](#)
- ▶ Windows UWP [HP Prime Pro](#) app
- ▶ Android [HP Prime Pro](#) app
- ▶ iOS [HP Prime Pro](#) app

**Required:** Installation requires the Connectivity Kit for [Windows or Mac](#).

## 1.1 New Installation

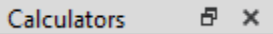
Step	Action
1	Download the installation files from <a href="https://sgss.ca/hpprime.html">https://sgss.ca/hpprime.html</a> .
2	Unzip/extract the installation files.
3	Navigate into the folder where the files were extracted, a folder  <code>SGSPrimeCOGO_v1_6_0_en</code> with the version number of the app will be found.
4	Open the folder to reveal a sub-folder with a <b>.hpappdir</b>  <code>SGS Prime COGO.hpappdir</code> extension inside.
5	Open the Connectivity Kit on your PC or Mac.
6	A. For physical HP Prime calculators; plug in the USB cable to connect. B. For HP Prime Pro apps; open the app on the device that is on the same Wi-Fi network as the PC or Mac running the Connectivity Kit.
7	Confirm your calculator connection, it will be visible in the  pane of the Connectivity Kit once connected.

8

Expand the connected calculator in the Connectivity Kit.

Drag and Drop the `SGS Prime COGO.hpappdir` folder from Step 4 onto the `Application Library` folder of your calculator. It may take a few seconds to complete the transfer.



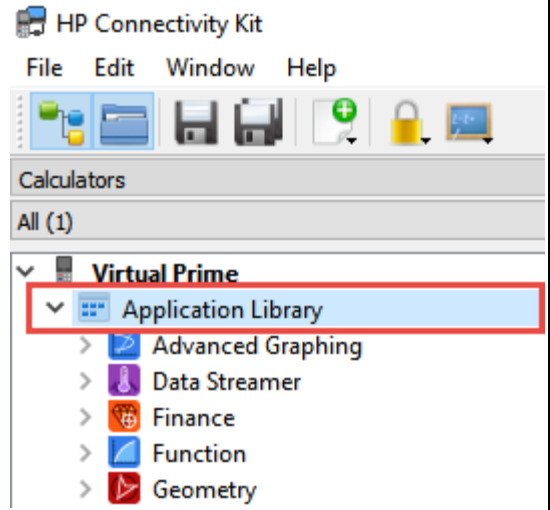







Close the Connectivity Kit.







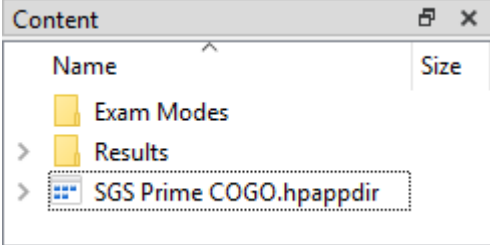

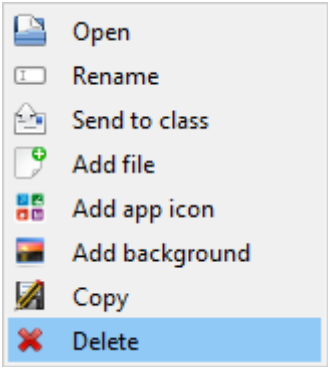





## 1.2 Upgrade to new Version

To preserve application variables and files, it is best to overwrite only the program code of the app when upgrading to a newer version. It is currently not possible to overwrite just the program code of an app directly in the **Application Library**; therefore, a workaround step is required to accomplish the upgrade.

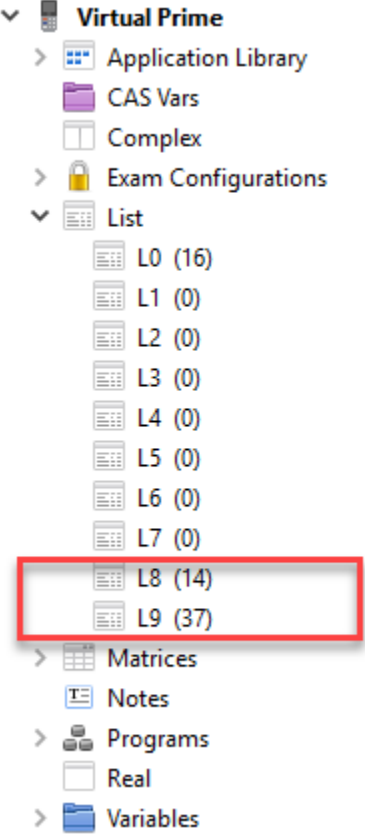
Step	Action
1	Download the installation files from <a href="https://sgss.ca/hpprime.html">https://sgss.ca/hpprime.html</a> .
2	Unzip/extract the installation files.
3	Navigate into the folder where the files were extracted, a folder  <b>SGSPrimeCOGO_v1_6_0_en</b> with the version number of the app will be found.
4	Open the folder to reveal a sub-folder with a <b>.hpappdir</b>  <b>SGS Prime COGO.hpappdir</b> extension inside.
5	Open the Connectivity Kit on your PC or Mac.
6	A. For physical HP Prime calculators; plug in the USB cable to connect. B. For HP Prime Pro apps; open the app on the device that is on the same Wi-Fi network as the PC or Mac running the Connectivity Kit.
7	Confirm your calculator connection, it will be visible in the <b>Calculators</b>   pane of the Connectivity Kit once connected.
8	<p>Expand the  <b>Application Library</b> folder and locate the  <b>SGS Prime COGO</b> app. Drag and drop the app into the <b>Content</b>   pane of the Connectivity Kit.</p> <p>This will create an <b>SGS Prime COGO.hpappdir</b> folder in the <b>Content</b> pane as shown.</p> 
10	<p>Right-click on the  <b>SGS Prime COGO</b> app in the  <b>Application Library</b> and choose <b>Delete</b>.</p> 

<p><b>11</b></p>	<p>Using your PC or Mac File Explorer, open the  <b>SGS Prime COGO.hpappdir</b> folder from Step 4.</p> <p>Inside you will find a  <b>SGS Prime COGO.hpappprgm</b> file, drag and drop this file onto the  <b>SGS Prime COGO.hpappdir</b> folder in the <b>Content</b>   pane.</p> <p>At the prompt choose <b>Yes</b> to replace the file.</p> <p>This updates the program code of the app in the <b>Content</b> pane.</p>
<p><b>12</b></p>	<p>Drag and Drop the  <b>SGS Prime COGO.hpappdir</b> folder from the <b>Content</b>   pane to the  <b>Application Library</b> folder.</p> <p>It may take a few seconds to complete the transfer.</p> <p>Close the Connectivity Kit.</p>
<p><b>13</b></p>	<p>NOTE: If you are upgrading from Version 1.5.x, you can delete the L8 and L9 lists that were installed with that version.</p> <p>Right-click on the L8 and L9 list objects and choose “Delete”.</p> 

**NOTE:** If you encounter an Insufficient Memory error when trying to connect with the Connectivity Kit, try:

1. Reboot the calculator by holding down  and then pressing . Try again.
2. If you have Version 1.5.1 or later installed, try the **Unload** option prior to connecting to the Connectivity Kit, then use the **Reload** option after upgrade is complete.

## 1.3 Running SGS Prime COGO

Once installed, run **SGS Prime COGO** by one of the following methods:

1. Open the Application Library on your calculator by using the **Apps Info** key. Locate the **SGS Prime COGO** app and tap the icon or **Start** on the menu to open the application.

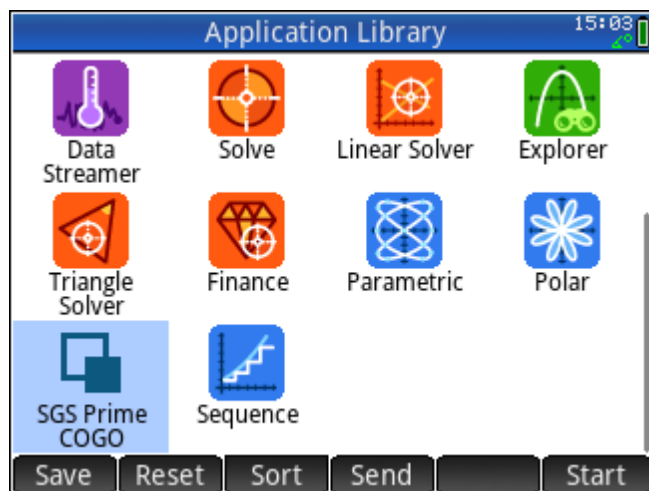

2. From the Home or CAS screen, if **SGS Prime COGO** is the active application with the title visible at the top of the screen, use the **Num** key to start the application.

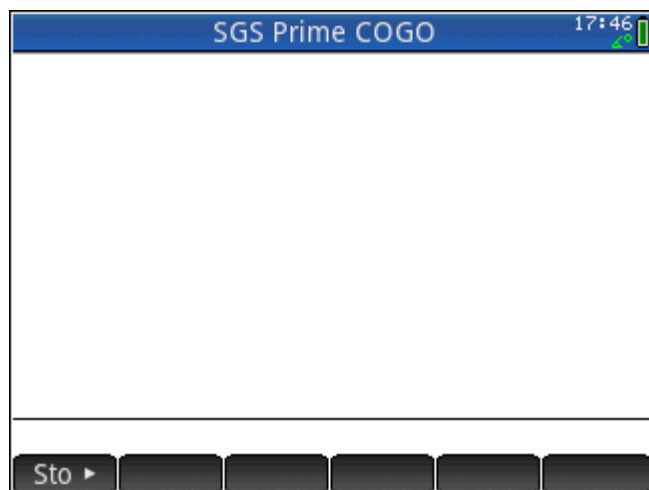

Other shortcut keys available from the Home or CAS screen:

- ▶ **Symb** starts the [RPN Calculator](#).
- ▶ **Plot** opens the [Plot Points](#) program.
- ▶ **Shift** and **Symb** / **Plot** / **Num** opens the [User Settings](#) options.

## 1.4 License Key

A valid **License Key** enables the functionality of the software.

License Keys are bound to the Device ID of the calculator or app that the SGS Prime COGO application is installed on.

You must supply the Device ID of your calculator or app when requesting a License Key.

The Device ID should match the calculator serial number followed by a few characters to help identify the type of device and the version of the app.

Contact [sales@sgss.ca](mailto:sales@sgss.ca) for more information about licensing.

Apply License Key

Device ID: FtCoDVT1n7-Emu1

License Key:

[Enter License Key to Activate](#)

Edit     Cancel Apply

## 2 Main Menu and User Interface

SGS Prime COGO is designed for touch and keyboard navigation.

### 2.1 Main Menu Screen

The user interface displays program settings and provides access to all program functions. The diagram below illustrates the screen layout.

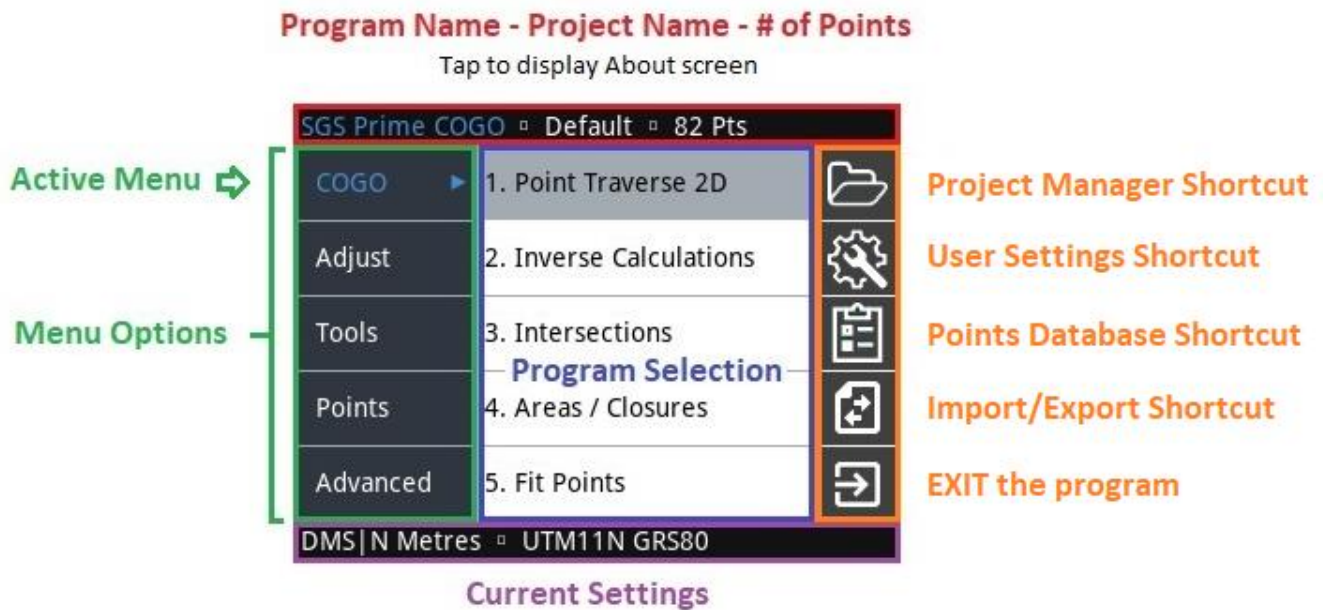

See the next two pages for descriptions of the various components.

Item	Description
<b>Project Name</b>	<p>Displays the current project name and the number of points stored in the current project.</p> <p>NOTE: Tap on this area to display the <b>About</b> screen.</p>
<b>Shortcuts</b>	<p>Often used functions are available on all main interface screens.</p>
<b>Current Project</b>	<p>Displays some of the available user settings.</p> <ul style="list-style-type: none"> <li>▶ <b>DMS</b> (360° ‘ ‘’) <b>D.d°</b> (360° decimal) <b>GON</b> (400 gons) indicates current Angle Unit setting.</li> <li>▶ <b> N</b> (North Bearings) <b> S</b> (South Bearings) <b> QB</b> (Quadrant Bearings) indicates current direction reference setting.</li> <li>▶ <b>Metres</b> (Metres) <b>IFeet</b> (International Feet) <b>USFeet</b> (US Survey Feet) indicates the current Distance Unit setting.</li> <li>▶ Coordinate system and associated ellipsoid.</li> </ul>
<b>Menu Options</b>	<p>Displays the titles of all menus, with the active menu name highlighted.</p> <ul style="list-style-type: none"> <li>▶ <b>COGO</b> menu</li> <li>▶ <b>Adjust</b> menu</li> <li>▶ <b>Tools</b> menu</li> <li>▶ <b>Points</b> menu</li> <li>▶ <b>Advanced</b> menu</li> </ul>
<b>Program Selection</b>	<p>Displays the available programs within each menu, with the currently selected program name highlighted.</p>

## About Screen

Tap the top of the main menu to display the About screen. The program version and license information is shown.

**Key** Update License Key. This will be necessary when upgrading an existing license from Lite to Standard, or Standard to Professional.

**Unload** Unload app data to reduce the memory size of the app folder. **Warning:** This removes all user-created content from the app and is intended for use prior to performing an app upgrade to a new version.

**Reload** Reload previously unloaded app data. Intended to be used immediately after performing an app upgrade to a new version.



## Project Manager Shortcut

Tap to access the Project Manager. Available options:

**New** Create a new Project. The name is entered, and common user settings are selected. Some of the User settings are stored with each project while others are applied to all projects; see the [User Settings](#) chapter for details.

**Delete** Delete the selected project. A confirmation prompt is displayed.

**Rename** Rename the selected project.

**Load** Load the selected project.

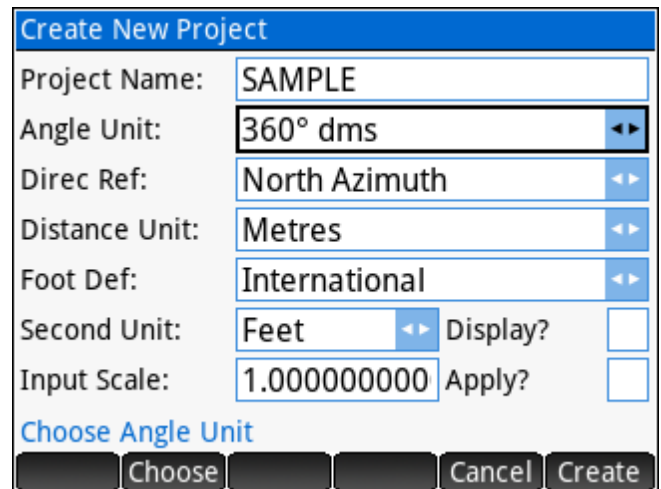
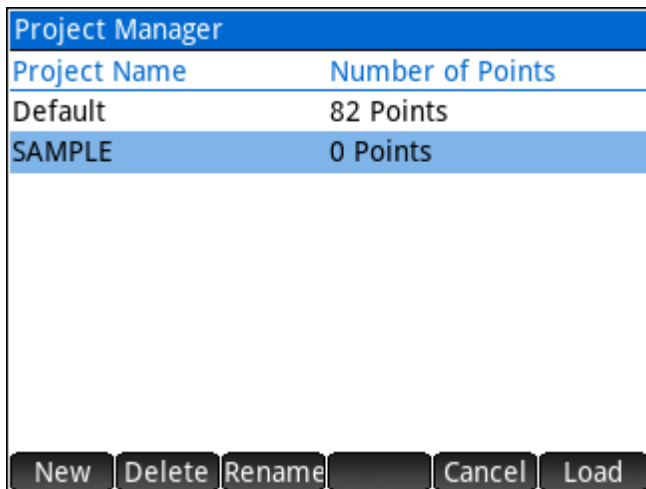

## User Settings Shortcut

Tap to access the User Settings. See the [User Settings](#) chapter.

## Points Database Shortcut

Tap to access the current project Points Database.

Points are sorted in numerical ascending order.

Available options:

**Edit** Edit the selected Point coordinates and description.

**Find** Find a point by Point ID.

**Page** Page Down, scrolls to the next page until the end of the database is reached.

**Page** Page Up, scrolls to the previous page until the start of the database is reached.

Points Database				
Point ID	North	East	Elev	Desc
23	2096.000	1086.000	0.000	SLIDE
24	2089.000	1089.000	0.000	SLIDE
25	2090.000	1099.000	0.000	SLIDE
31	120.000	220.000	0.000	HINGE
32	130.000	220.000	0.000	HINGE
33	130.000	210.000	0.000	HINGE
34	111.000	203.000	0.000	HINGE
35	109.000	208.000	0.000	HINGE
41	7444.140	5354.860	0.000	FIT_CURVE

**Edit** **Find** **Page** **Page** **Cancel** **OK**

## Find Points

Enter a Point ID to display the coordinates and description of the Point ID. Scroll to view information of the adjacent points, as sorted numerically.

While viewing point information:

**Edit** Edit the currently displayed point.

**Cancel** Exit the Find Points program and return to the Main Menu.

**OK** Return to the Input Form.

**Find Point**

Point ID:

Enter Point ID to find

**Edit** **Cancel** **Find**

**Find Point**

Point Coordinates (2/82)

Point ID: 11  
North: 2979.043m  
East: 2000.180m  
Elev: 0.000m  
Description: AREA









Up / Down to Scroll ...  
ESC / ENTER to finish ...

**Edit** **Cancel** **OK**



## 2.2 Keyboard

Navigate the main user interface by using the directional cursor keys. Use the ◀ and ▶ cursor keys to change the current menu and use the ▲ and ▼ cursor keys to change the current selection.

- ▶  will load the currently selected program.
- ▶  or  will exit **SGS Prime COGO**.
- ▶ Numeric keys  through  can be used to run the corresponding program from each menu.
- ▶  launches the [RPN Calculator](#) app from the Main Menu or from any Input Form.
- ▶  opens the [Plot Points](#) program.
- ▶  opens the Points Database.

## 2.3 Input Forms

Input forms are used throughout the program to accept multiple different types of input. Some common input types are: **Point IDs / Point Ranges / Directions / Angles / Distances / Coordinates / Stations / Grades / Text / Choose Lists / Checkboxes**

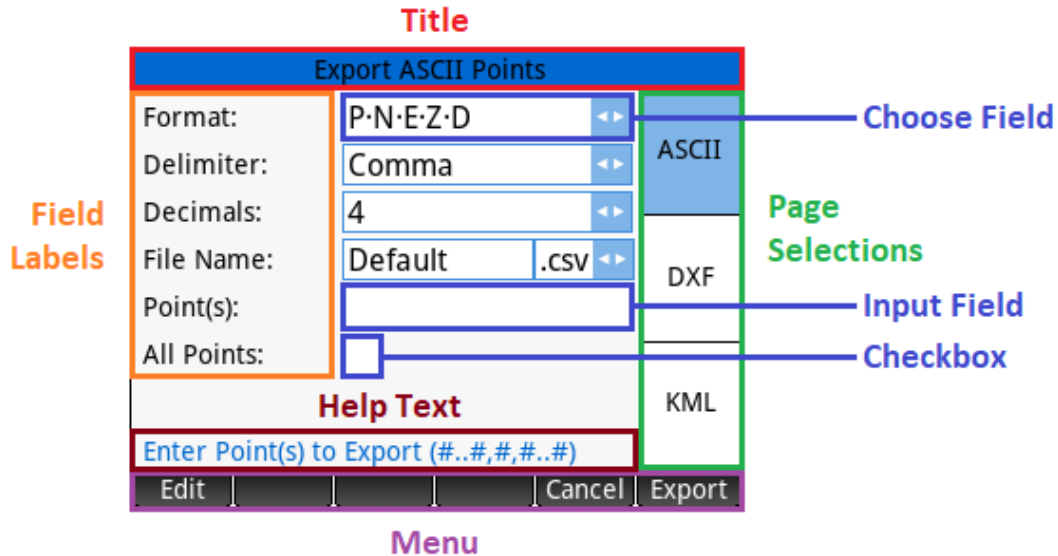



Each input form will have some of the same basic elements, such as the Title, Field Labels, Input Fields, Help Text and a Menu. Some input forms feature more than one page, the page selections can be made on the right edge of the screen. The touch screen and keyboard can be used to select fields.



Current display settings control the appearance of each field.

NOTE: The [RPN Calculator](#) app can be launched from any input form by using the  key.

### Copy and Paste

The clipboard can hold multiple items, which are stored as strings as would be entered into an input field.

 and  can be used to copy the value inside the selected field, or the value being edited.

 and  can also be used to paste from the clipboard.

The Copy/Paste functionality is a good method to transfer calculated values to/from an Input Form and the [RPN Calculator](#).

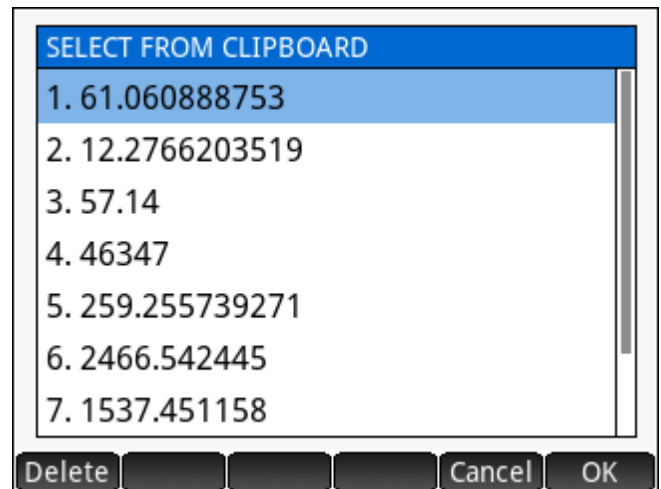

## Touchscreen keypads

When any editable input field is selected, tap on the field to open the touchscreen keypad to enter a value. There are two types of keypads, numeric and alpha-numeric.

### Numeric keypad

Any time a numeric field is edited, the numeric keypad opens. The title of the keypad is the help text of the field being edited, and a “helper” button is to the right of the edit line, which can vary depending on the type of input field you’re editing. The example shows a distance field being edited, as a result the helper button shows the secondary distance unit to convert from secondary to primary distance units.

Copy and paste is functional here too, as are the keys on the keyboard of the calculator.

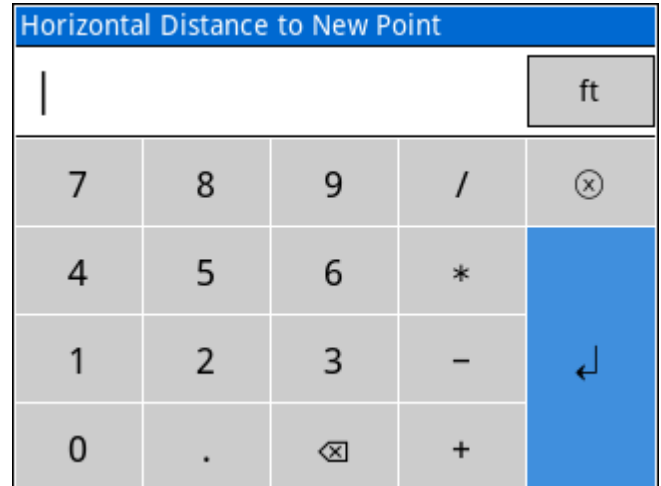



### Alpha-numeric keypad

Any time an alpha-numeric field is edited, the alpha-numeric keypad opens. The title of the keypad is the help text of the field being edited.

This keypad can have three different sets of characters:

- Uppercase alphabetic (with top row of numbers)
- Lowercase alphabetic (with top row of numbers)
- Numbers and special characters

The  and  keys can be used to switch between modes.

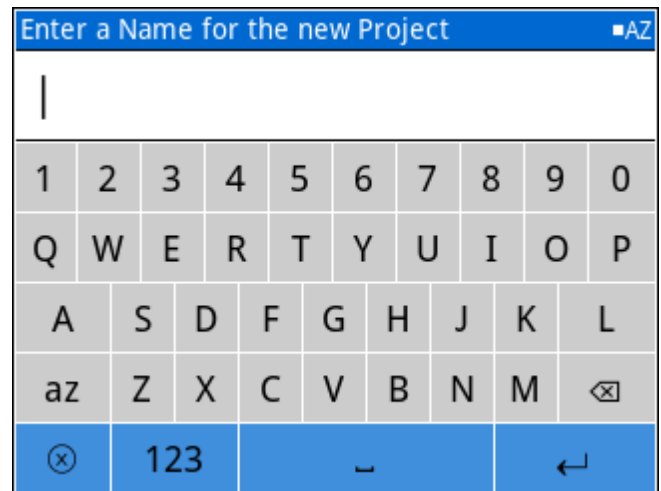

Depending on the language of the installed app, the keypad may respond to long presses on certain keys to show accent characters where applicable.

## Point IDs

A single Point ID can be input by simply entering the number. Depending on the context of where the input is requested, there may be requirements that the point exists or does not exist.

While editing a Point ID field where an existing Point is required, the menu will change to display **Browse** on the first menu label. Pick this option to open the Point Database browser where a Point can be selected from the database.

Point Traverse - Plus

From Point: 3

Mode: Traverse

Offsets:

Std

4 R

Plus

Curve

Start Calculation From Point

Browse Cancel OK

## Point Ranges

To input a range of points:

- ▶ Enter a range of points in the format “From..To”, for example **1..5**, to input a range of point numbers.
- ▶ Enter a combination of point ranges and individual points, for example **1..5 7 9..15**, where each range or individual point is separated by a space or comma.
- ▶ Often a checkbox labeled **All Points** is available to select all points in the current project.

Rotate Points

Point(s): 10..15

All Points:

Calc Points: Overwrite

Additive #:

Description: COGO Original?

All Points?

Cancel Calc

## Directions

A direction input can be a full circle bearing or a quadrant bearing. The prompt will depend on the [direction reference](#) user setting.

- ▶ Enter a 360° full circle bearing input in the DDD.mmss format. For example, 123°45'12" is entered as **123.4512**.
- ▶ Enter a quadrant bearing input in the QDD.mmss format, where Q is the quadrant (1 to 4). For example, N24°34'55"W is entered as **424.3455**.
- ▶ Enter two points in the “From..To” format to inverse the direction between two existing points in the job database. For example, enter **1..2** to inverse the direction from Point 1 to Point 2.

Point Traverse - Plus

Bearing 1: 10.11

Offset: 0.000m

Direction from Point 1203 (Blank if unknown)

QB->B ±180° Rad Cancel OK

- ▶ Subtract or add angles to/from a line direction by entering “From..To+Angle” or “From..To-Angle”. For example, **1..2+30.3055** will inverse the direction from Point 1 to Point 2 and add 30°30’55” to it.
- ▶ Perform complex calculations using standard algebraic entry with current angle unit settings. For example, **1..2+30.17-2.35-1.44** will inverse the direction from Point 1 to Point 2, then add 30°17’, then subtract 2°35’, and then subtract another 1°44’.
- ▶ Repeat the last entry by entering **++** as input.
- ▶ **QB→B** While editing a direction field, pick this option to convert between quadrant bearings and full circle bearings.
- ▶ **±180°** While editing a direction field, pick this option to reverse the direction.
- ▶ **Rad** While editing a direction field, pick this option to enter a value in radians.

## Angles

Angles work in a similar fashion as directions except that the input MUST be a real number or a complex calculation involving only real numbers.

## Distances

Distance input is like direction input:

- ▶ Enter two points in the “From..To” format to inverse the distance between two existing points in the job database. For example, enter **1..2** to inverse the distance from Point 1 to Point 2.
- ▶ Subtract or add a distance from a line distance by entering “From..To+Distance” or “From..To-Distance”. For example, **1..2+30.1** will inverse the distance from Point 1 to Point 2 and add 30.1 units to it.
- ▶ Divide or multiply a line distance by a factor by entering “From..To\*Factor” or “From..To/Factor”. For example, **1..2/5** will inverse the distance from Point 1 to Point 2 and divide the result by 5.
- ▶ Perform complex calculations using standard algebraic entry. For example, **1..2+(30.214/3)-5** will inverse the distance from Point 1 to Point 2, then add one third of 30.214, then subtract 5.
- ▶ Repeat the last entry by entering **++** as input.
- ▶ **ft** While editing a distance field, pick the first menu button to convert a distance entered from the secondary distance unit to the primary distance unit.

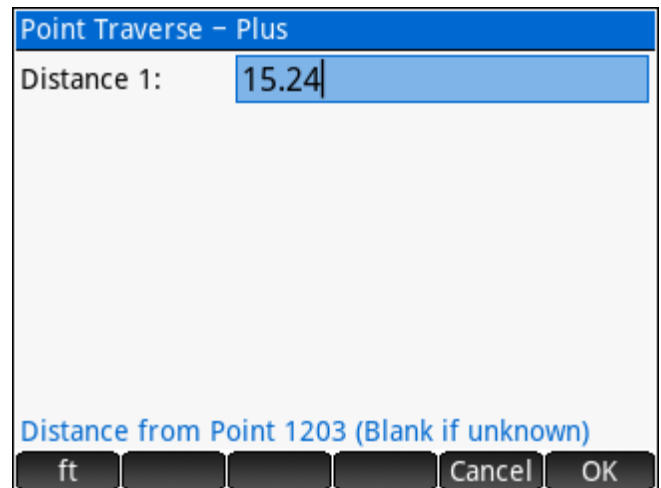

## Feet, Inches, Fractions

Feet, Inches and fractions may be input into any distance fields by delimiting each part by a comma character. This input type will always convert to the current unit setting once entered. The tables below show example use cases to illustrate how this entry method is implemented.

### Project Distance Unit set to Metres

User Entered Value	Interpreted As	Displayed As (3 decimal places)
10	10m	10.000m
10,	10'	3.048m
10,6	10'-6"	3.200m
10,6,1/2	10'-6 1/2"	3.213m
10,6,15/32	10'-6 15/32"	3.212m
10,6,7	10'-6 7/16"	3.212m

### Project Distance Unit set to Feet

User Entered Value	Interpreted As	Displayed As (1/16 precision)
10	10'	10'
10,	10'	10'
10,6	10'-6"	10'-6"
10,6,1/2	10'-6 1/2"	10'-6 1/2"
10,6,15/32	10'-6 15/32"	10'-6 1/2"
10,6,7	10'-6 7/16"	10'-6 7/16"

## Coordinates

Coordinate values must be entered as real numbers, or as complex calculation involving real numbers. Coordinates are displayed with current unit suffix once entered.



## Stations

Station values must be entered as real numbers, or as complex calculation involving real numbers. Stations are displayed with current station format once entered, 0+00 / 0+000 / No Format.

## Grades

Grade values must be entered as real numbers, or as complex calculation involving real numbers. Grades are displayed with grades format once entered, % (V/H\*100) / Ratio V:H / Ratio H:V.

## Text

Text fields will accept a certain range of characters as valid input. Use  and  to enter the characters required. Available characters include (see next page):

Default	1 2 3 4 5 6 7 8 9 0 . , + - * /
<b>ALPHA</b> alpha enabled:	A B C D E F G H I J K L M N O P Q R S T U V W X Y Z # : . ;
<b>ALPHA</b> alpha and <b>Shift</b> enabled:	a b c d e f g h i j k l m n o p q r s t u v w x y z # : = _ ;

## Choose Lists

Choose lists contain a pre-defined set of options to choose from. Selections can be made by:

- ▶ Tapping on the field to open the list of possible selections to pick.
- ▶ Tapping **Choose** once the field is selected.
- ▶ Cycling through available options using the keyboard ◀ and ▶ buttons.

The current selection is displayed with a checkmark when the list is expanded.





## Checkboxes

Checkboxes are toggles to set a flag True or False. In some cases, the state of the checkbox may disable or enable other fields in the input forms. Checkboxes can be toggled by:

- ▶ Tapping on the field.
- ▶ Tapping  once the field is selected.
- ▶ Using the keyboard ◀ and ▶ buttons.

## 2.4 Choose Boxes

Choose boxes present a list of multiple options from which to choose. Selections can be made by:

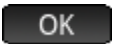
- ▶ Tapping on the option row selects the option, and when already selected will complete the selection and advance to the next step.
- ▶ Use the keyboard shortcut keys  to  to make a selection. This action will also complete the selection and advance to the next step.
- ▶ Cycling through available options using the keyboard  and  buttons. Use  to advance to the next step.
- ▶ When a list is longer than 7 items, a scrollbar is shown and the list can be scrolled with the touchscreen.

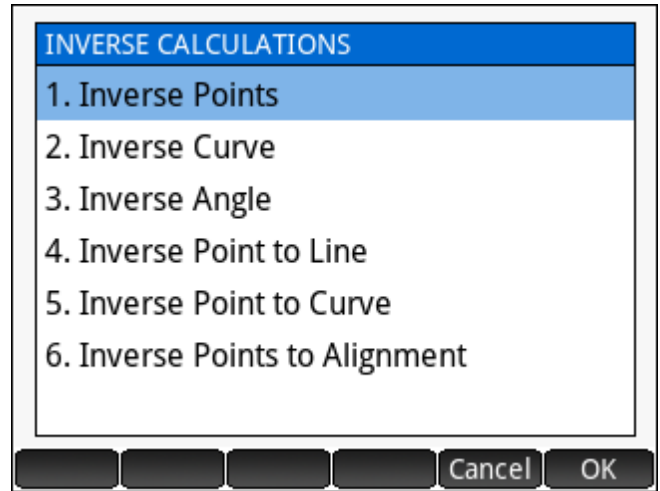

## 2.5 Output Screens

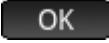
Output screens display the results of calculations and do not accept input. Some output screens feature a menu to provide access to further calculations related to the data, while other output screens will only feature a  menu option.

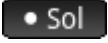
Some output screens consist of multiple pages; the active page is differentiated with a filled circle character preceding the menu label, for example .

Many output screens also feature a  menu button. This allows the user to select one of the solved values to copy to the clipboard.

Many output screens also feature a  menu button. This allows the user to select one of the solved values to store to a named variable.

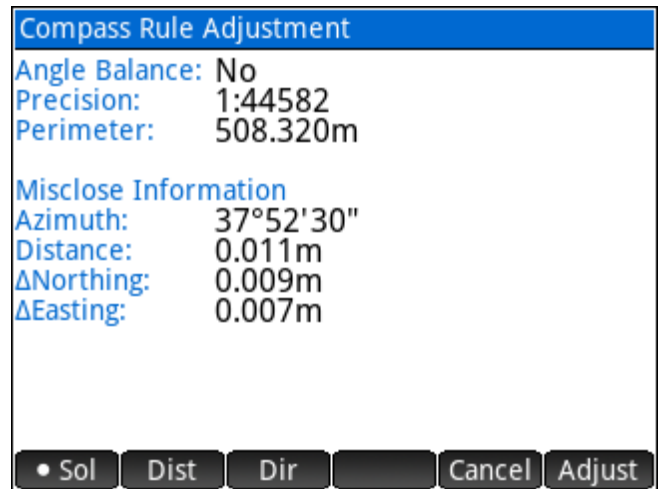



# 3 User Settings

Various settings allow the user to configure the software to function to his/her preference. It is important to review all the settings prior to using the software to ensure they are set to produce the desired results.

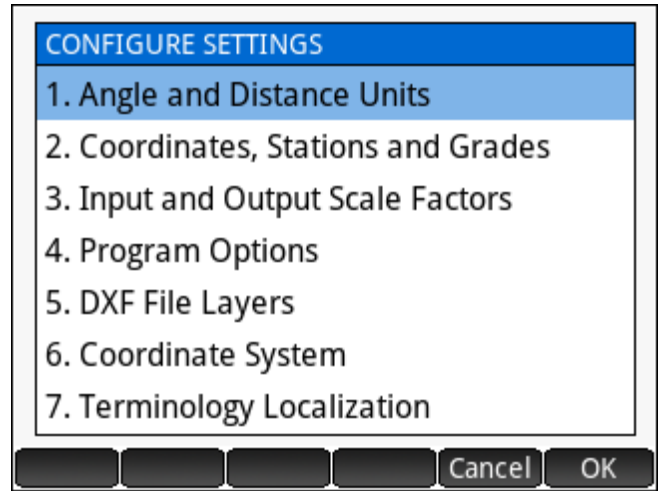

## 3.1 Angle and Distance Units

Unit settings affect input interpretation and representation.

### Angle Unit

The angle unit may be set to **360°''' dms**, **360° dec** or **400 gon**. Angular and directional input and output will honour this setting for all functions.

### Angle Precision

Angles and directions are displayed with the specified number of decimals.

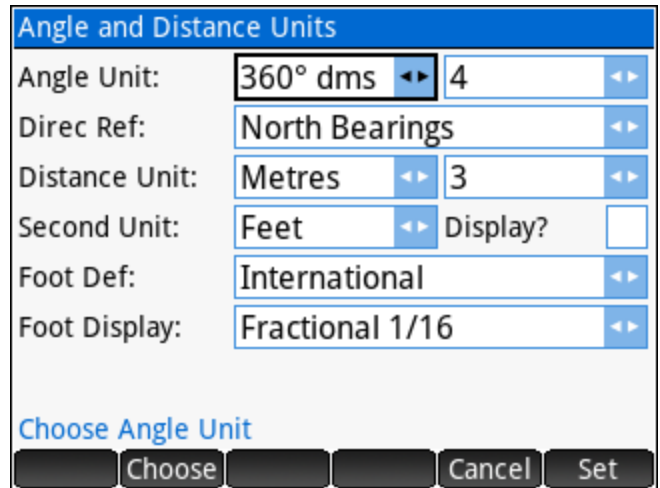

### Direction Reference

Direction reference may be set to **North Bearings**, **South Bearings**, or **Quadrant Bearings**.

- ▶ **North bearings** are defined by declaring north to be 0° (or 0g) while **south bearings** are defined by declaring south to be 0° (or 0g), and then measuring the full circle in a clockwise direction. Direction input and output are subject to both angle unit and direction reference settings.
- ▶ **Quadrant bearings** split the circle into NE, SE, SW, and NW quadrants, always measuring angles from north or south towards east or west. Quadrants are numbered 1-4 to facilitate fast input of quadrant bearings. For example, to enter a bearing of N36°43'15"W; the user would enter **436.4315** because the NW quadrant = quadrant 4.

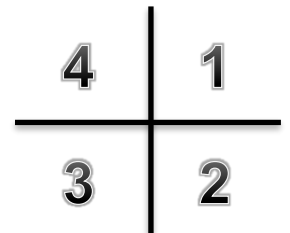

## Distance Unit

The distance unit may be set to **metres** or **feet** for display and conversion purposes.

The distance unit setting DOES NOT AFFECT JOB COORDINATES. The distance unit is for input/output display only. To convert a project from metric to imperial, or vice versa, use the [Scale Points](#) option. This behaviour is consistent with how a CAD drawing operates. The coordinates are essentially unit-less, and this setting determines input and output display/calculations.

## Distance Precision

Distances are displayed with the specified number of decimals.

## Secondary Unit

The secondary unit may be set to **metres**, **feet**, **links** or **chains**. This setting determines the unit that can be used for quick conversions (to the primary unit) within distance input fields.

## Display Secondary Unit

This toggle determines if calculated distance results will be displayed in the primary unit only, or both primary and secondary units.

## Foot Definition

The foot definition setting may be set to **US Survey Foot** or **International Foot** for use with all conversions between metric and imperial.

- ▶ The definition of a **US Survey Foot** is exactly 1200/3937 metres, approximately 0.304800609601 metres.
- ▶ The definition of the **International Foot** is exactly 0.3048 metres.

## Foot Display

The foot display setting may be set to **Decimal** or **Fractional 1/16** for displaying distances in feet units.

## 3.2 Coordinates, Stations and Grades

Modify the display of coordinates, stations and grades.

### Coordinate Display

The coordinate display format may be set to display coordinates in the order of **Northing, Easting, Easting, Northing** or **X,Y**. This setting changes the order and labels for most cases where coordinates are input and/or displayed.

### Coordinate Precision

Coordinates are displayed with the specified number of decimals.

### Stationing Display

The stationing display format may be set to display stations in the format **0+00**, **0+000** or without any formatting.

### Stationing Precision

Stations are displayed with the specified number of decimals.

### Grade Display

The grade display format may be set to display grades as percentage grades **% (V/H\*100)**, ratio **V:H**, or ratio **H:V**. This setting applies to input and output of grades.

### Grade Precision

Grades are displayed with the specified number of decimals.

The screenshot shows a dialog box titled "Coordinates, Stations and Grades" with a blue header. It contains several settings, each with a text input field and a double-headed arrow button on the right:

- Coord Display:** A dropdown menu showing "North, East".
- Precision:** A text input field containing the number "3".
- Stations:** A text input field containing "0+000".
- Precision:** A text input field containing the number "3".
- Grades:** A text input field containing "% (V/H\*100)".
- Precision:** A text input field containing the number "1".

At the bottom of the dialog, there is a blue link that says "Choose Coordinate Display". Below this link are four buttons: a small grey button, a "Choose" button, a "Cancel" button, and a "Set" button.

### 3.3 Input and Output Scale Factors

The Input Scale Factor, when enabled, is applied to all distance entries to automatically scale the distance by the specified scale factor. The Output Scale Factor, when enabled, is applied to all calculated distances to automatically scale the calculated distance. The primary use of these settings is to calculate grid coordinates by entering ground distances. The settings can also be used to work with alternate units, such as entering feet dimension in a metric project.

Input and Output Scale Factors

Input Scale: 1.000000000000

Apply?

Inverse?

Output Scale:

Apply?

[Enter Input Scale Factor](#)

Edit Cancel Set

#### Input Scale Factor

The Input Scale Factor will be applied to any entered distance values when the toggle is set.

#### Apply Input Scale Factor

Toggle the application of the Input Scale Factor.

NOTE: When the Input Scale Factor is being applied, all distance input fields will display an asterisk after the distance value once the input has been entered and parsed, for example **30.000m \***.

#### Inverse?

Toggle the automatic calculation of the Inverse of the Input Scale Factor to set the Output Scale Factor.

#### Output Scale Factor

The Output Scale Factor will be applied to all calculated distances when the toggle is set.

#### Apply Output Scale Factor

Toggle the application of the Output Scale Factor.

NOTE: When the Output Scale Factor is being applied, all calculated distance values will be scaled by this factor, and the resulting value will be displayed with an asterisk, for example **30.000m \***.

### 3.4 Program Options

Program Options are settings that affect how the program will handle certain situations.

#### Radius Tolerance

Enter a value to set the radius tolerance, used primarily by **Inverse Curve** and **Area by Points**. The distance from the BC point to the Radius point and the distance from the EC point to the Radius point cannot differ by more than this value, otherwise the points will not define a valid curve. The average of the two values  $((BC..CC+EC..CC)/2)$  is used as the radius for a curve.

Program Options	
Radius Tol:	0.010000000000
Time/Date:	
Auto Exit Time:	5 Minutes
Clipboard Size:	10

[Tolerance for Curve Radius difference](#)

Edit [ ] [ ] [ ] Cancel Set

#### Time/Date

Toggle the display of the time and date in the header of the program.

#### Auto Exit Time

Set the timeout duration for inactivity. After the specified time limit the app will start a close sequence that will see the app completely exit out. This is done to allow the calculator to go to sleep to save battery life.

#### Clipboard Size

Set the maximum number of items that the clipboard will hold, must be a number in range of 1 to 100.

### 3.5 DXF File Layers

DXF File Exports are available for some routines, and the DXF File Layers settings are used when exporting the entities.

Default layer names and colours will be used until the user changes the name or colour settings.

	Layer Name	Layer Colour
Linework:	SGS_LINES	Blue
Point Node:	SGS_PTNODE	Red
Point ID:	SGS_PTID	White
Elevation:	SGS_PTELEV	Yellow
Description:	SGS_PTDESC	Cyan

[Linework Layer Name](#)

Edit [ ] [ ] [ ] Cancel Set

## 3.6 Coordinate System

Coordinate System Settings are used for [Coordinate Conversions](#) and [Ellipsoid Calculations](#).

### Projection

Various pre-defined projections are included. Coordinate systems are grouped by region and projection type. Available reference ellipsoids vary depending on the coordinate system selected. Touch the button displaying the currently set projection to change it.

### [Coordinate System Groups](#)

The available coordinate system groups are:

1. UTM Zones North
2. UTM Zones South
3. US State Planes, NAD27
4. US State Planes, NAD83
5. Other US
6. Canadian
7. European
8. Australia / New Zealand
9. South American
10. Central American
11. African
12. Middle East
13. [User Defined](#)

On the menu use the **Info** option to display the parameters of the currently set coordinate system.

Select a group to display the available coordinate systems.

The screenshot shows a dialog box titled "Coordinate System". It contains several input fields and buttons. The "Projection" field is set to "UTM Zone 11". The "Radius Method" dropdown is set to "Geometric Mean". The "Earth Radius" field is set to "6372000.000m". The "Vertical Sys" dropdown is set to "Ellipsoidal". The "Geoid Height" field is set to "0.000m". At the bottom, there is a link "Earth Radius to compute Elevation Factor" and four buttons: "Choose", "Cancel", and "Set".

The screenshot shows a dialog box titled "Select Group". It contains a list of coordinate system groups. The "Coordinate System Group" header is followed by a list of options: "UTM Zones North", "UTM Zones South", "US State Planes, NAD27", "US State Planes, NAD83", "Other US", "Canadian", "European", "Australia / New Zealand", and "South American". At the bottom, there are four buttons: "Info", "Page", "Cancel", and "OK".

The screenshot shows a dialog box titled "Current Coordinate System Info". It displays the following information:

Long Name:	UTM Zone 11
Short Name:	UTM11N
Proj. Type:	Transverse Mercator
Origin Lat:	N0°00'00.00000"
Central Merid:	W117°00'00.00000"
Scale:	0.9996000000
False East:	500000.0000m
False North:	0.0000m
Ellipsoid:	GRS80
Semi-major:	6378137.000m
Semi-minor:	6356752.314m

At the bottom, there are four buttons, with the rightmost one labeled "OK".

## Coordinate Systems

The available coordinates systems for the selected group are displayed, choose the coordinate system.

## Reference Ellipsoid

Depending on your chosen coordinate system; you may be presented with a list of options to select the reference ellipsoid. A reduced list, or automatic selection is made for those coordinate systems that are specifically based on a certain ellipsoid.

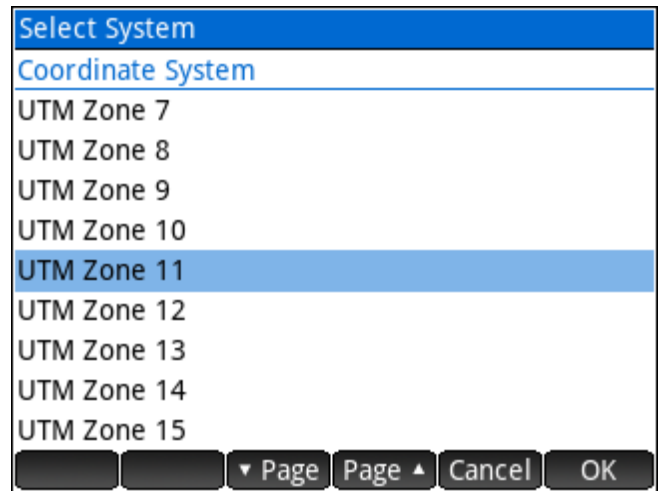

Various commonly used ellipsoid definitions are included. Available options are:

1. Clarke 1866 (NAD27)
2. GRS80 (NAD83)
3. WGS84
4. International 1924 (Hayford)
5. Clarke 1880 (ARC)
6. Clarke 1880 (IGN)
7. Clarke 1880 (RGS)
8. Airy 1830
9. Airy 1830 (Modified)
10. Australian National Spheroid
11. Krassovsky 1940
12. Bessel 1841
13. Parametry Zemli 1990 (PZ-90)
14. [User Defined](#)

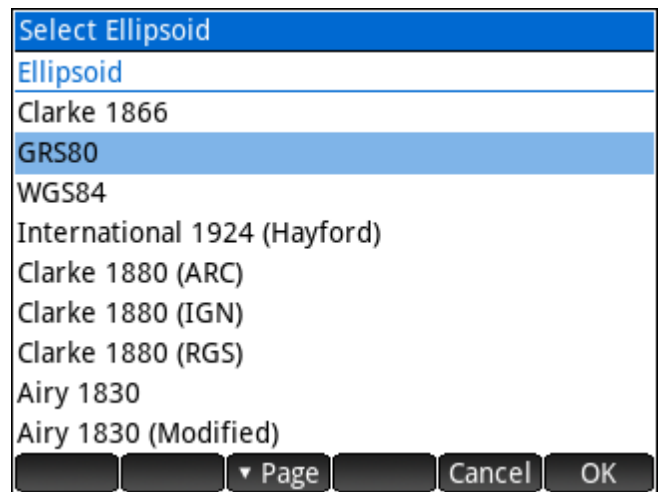

## Radius Method

Choose the method to determine the earth radius to use for elevation factor calculations. Options include:

- ▶ **Geometric Mean** – Calculates the geometric mean earth radius for each point, using the formula:

$$r = \frac{a \times \sqrt{1 - e^2}}{1 - e^2 \times (\sin \phi)^2} \quad \text{where } a = \text{semi-major axis (radius at equator)} \quad e^2 = \text{eccentricity squared}$$

and  $\phi$  = geodetic latitude. This is the most accurate method.

- ▶ **6372000m** – Commonly used mean earth radius, may not be ideally suitable for all regions.
- ▶ **User Entered** – Some regions have adopted a mean earth radius that best fits their region.

## Earth Radius

When the **Radius Method** is set to *User Entered*, enter the appropriate value for the coordinate system.

## Vertical System

Choose the vertical system that will be used to arrive at ellipsoid heights for various calculations. The options are *Ellipsoidal* (requires no conversion) or *Average Geoid Height* (applies average geoid separation to obtain ellipsoid heights). Geoid file support is planned for a future release.

## Average Geoid Height

The average geoid height for your project area. Ellipsoid heights (h) are calculated by adding the orthometric height (H) and the *geoid height* (N).  $h = H + N$  therefore  $N = h - H$

## User Defined Coordinate Systems

When selecting *User Defined* as the **Coordinate System Group**, a list of user-created coordinate systems is displayed.

Use the **New** option on the menu to create a new coordinate system. The user can choose the projection type to create the new coordinate system. The input form that follows will prompt for the appropriate parameters required to define the coordinate system.

A final input form accepts a long and short name for the coordinate system and the Hemisphere & Orientation selections.

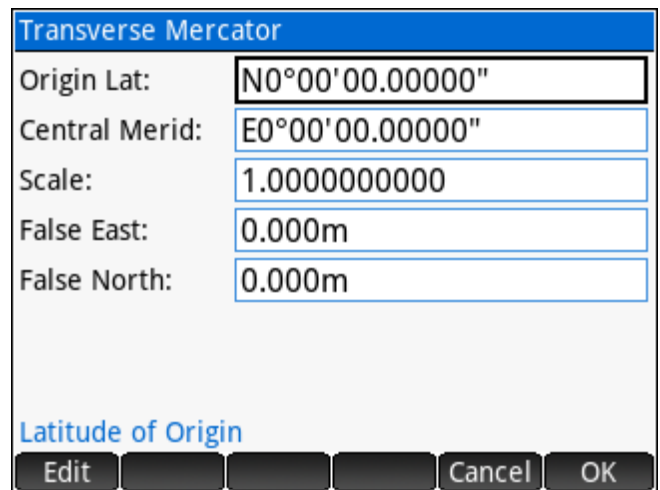
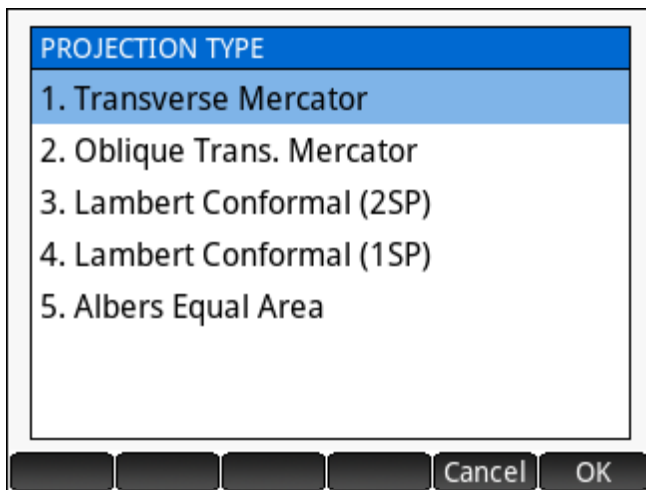
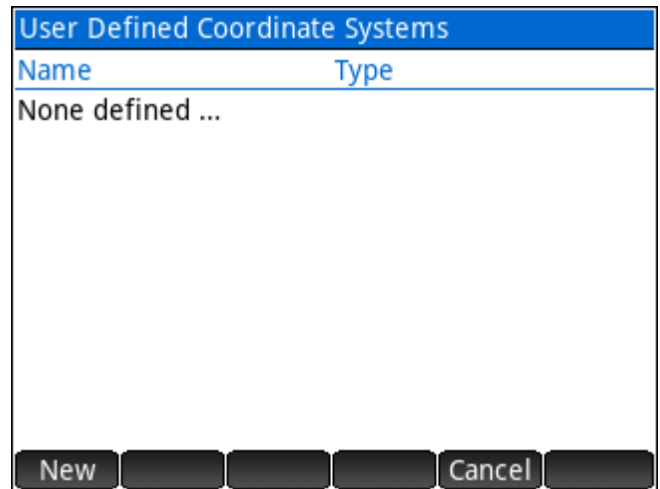

Once created; the custom coordinate system may be selected as the chosen coordinate system or edited if required.



## User Defined Ellipsoids

When selecting *User Defined* as the **Ellipsoid**, a list of user-created ellipsoids is displayed.

Use the **New** option on the menu to create a new ellipsoid. The input form accepts all the required information. The second parameter of the ellipsoid can be either the *Semi-minor axis* or the *Inverse Flattening* parameter.

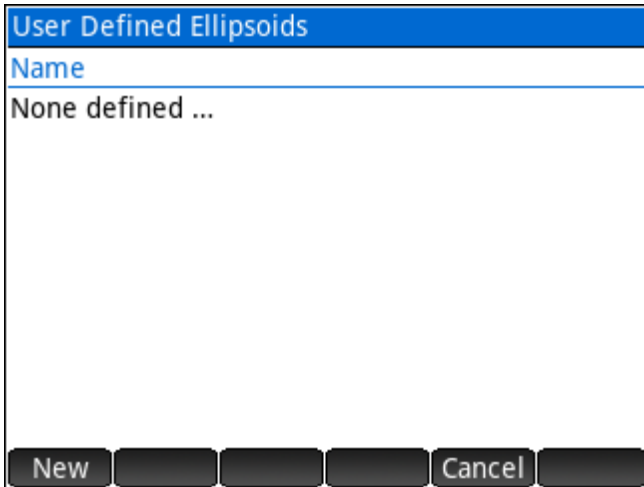

The dialog box titled "User Defined Ellipsoids" has a blue header. Below the header is a text area labeled "Name" containing the text "None defined ...". At the bottom of the dialog are five buttons: "New", a blank button, a blank button, "Cancel", and a blank button.

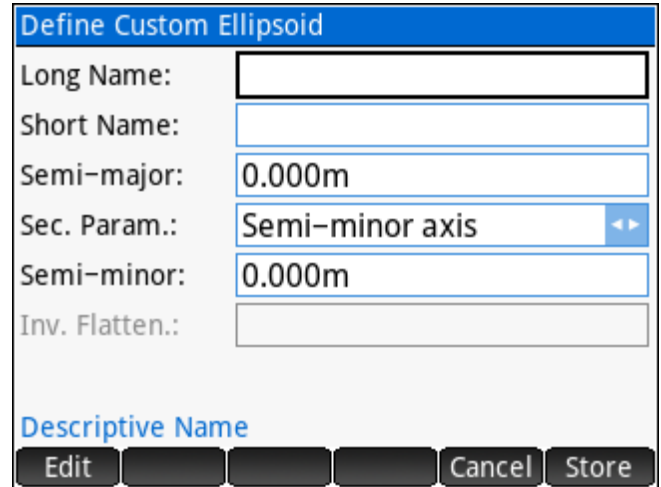

The dialog box titled "Define Custom Ellipsoid" has a blue header. It contains several input fields: "Long Name:" (empty), "Short Name:" (empty), "Semi-major:" (0.000m), "Sec. Param.:" (Semi-minor axis), "Semi-minor:" (0.000m), and "Inv. Flatten.:" (empty). Below these fields is a section labeled "Descriptive Name" with a blue header. At the bottom are five buttons: "Edit", a blank button, a blank button, "Cancel", and "Store".

Once created; the custom ellipsoid may be selected as the chosen ellipsoid or edited if required.

## 3.7 Terminology Localization

Terminology localization allows the user to control some of the terminology used throughout the program.

Standard terminology differs between regions. When the calculator settings are set to English language, then this option will be available in the **SGS Prime COGO** settings. The available region selections are:

- ▶ CAN / USA (Canada / USA)
- ▶ AUS / NZL / ZAF (Australia, New Zealand, South Africa)



The dialog box titled "Terminology Localization" has a blue header. It contains a dropdown menu labeled "Region:" with the selection "CAN / USA". Below the dropdown is a section labeled "Choose Region for Terminology" with a blue header. At the bottom are five buttons: a blank button, "Choose", a blank button, "Cancel", and "Set".





## 3.8 Settings Use and Application

The table below outlines which settings are specific to the current project, and which ones are constant until changed explicitly. When creating a new project, the current project's 'project specific' settings will be the default suggested values.

Setting	Project Specific or Constant
Angle Unit	Project Specific
Angle Unit Precision	Constant
Direction Reference	Project Specific
Distance Unit	Project Specific
Distance Unit Precision	Constant
Foot Definition	Project Specific
Secondary Distance Unit	Project Specific
Display Secondary Unit	Project Specific
Coordinate Display Format	Constant
Coordinate Precision	Constant
Station Display Format	Constant
Station Precision	Constant
Grades Display Format	Constant
Grades Precision	Constant
Input Scale Factor	Project Specific
Input Scale Toggle	Project Specific
Inverse Calculation toggle for Output	Project Specific
Output Scale Factor	Project Specific
Output Scale Toggle	Project Specific
Radius Tolerance Value	Constant
Point Traverse App	Constant
Header Time and Date	Constant
DXF File Layers	Constant
Coordinate System	Project Specific

## 4 COGO Menu

- ▶ [Point Traverse 2D](#) – The primary COGO routine used to calculate point coordinates.
- ▶ [Inverse Calculations](#) – **Inverse Points**, **Inverse Curve**, **Inverse Angle**, **Inverse Point to Line**, **Inverse Point to Curve**, and **Inverse Point to Alignment**.
- ▶ [Intersections](#) – **Bearing-Bearing**, **Distance-Distance**, **Bearing-Distance** and **Distance-Interior Angle**.
- ▶ [Areas / Closures](#) – **Area by Points**, **Subdivide by Sliding Bearing**, **Subdivide by Hinge Point**, and **Closures**.
- ▶ [Fit Points](#) – **Fit to Straight Line** (Linear Regression), **Fit to Circular Curve**, **Double Proportion**, **Irregular Boundary** and **Grant Boundary**.

SGS Prime COGO ▾ Default ▾ 82 Pts		
COGO ▶	1. Point Traverse 2D	
Adjust	2. Inverse Calculations	
Tools	3. Intersections	
Points	4. Areas / Closures	
Advanced	5. Fit Points	
DMS   N Metres ▾ UTM11N GRS80 Vt=Ellip		

### 4.1 Point Traverse 2D

**Point Traverse 2D** is the main COGO application and is available in three configurations: **Standard**, **Angle Right** and **Plus**. The **Curve Traverse** option is used to calculate points from curve information.

Each of the three configurations will have a Mode option which controls automatic Point ID updating while calculating:

- ▶ **Traverse** – Traverse Mode will always advance the From Point to the new Point ID that gets stored when completing a calculation. This is ideal if calculating the perimeter of a parcel, for example.
- ▶ **Sideshot** – Sideshot Mode does not advance the From Point when a calculation is completed. This is ideal for calculating numerous points from the same base point.

## Point Traverse - Standard

**Point Traverse – Std** is a COGO application that accepts all input within a single input form.

### 'From Point' Field

This field requires an existing point number to use as the starting point, or station. Entering a point number that does not exist in the job will result in the option to create a new point.

All the Inverse Calculations as described under the [Point Traverse - Plus](#) section are also accepted.

Point Traverse - Std		
From Point:	<input type="text" value="6"/>	Std
Bearing:	<input type="text" value="74°25'00"/>	
Distance:	<input type="text" value="50.000m"/>	4 R
Offset:	<input type="text" value="0.000m"/>	
Mode:	<input type="text" value="Traverse"/>	Plus
<b>Perpendicular Offset (+Right, -Left)</b>		Curve
<input type="button" value="Edit"/> <input type="button" value="Cancel"/> <input type="button" value="Calc"/>		

### 'Bearing' Field

This field requires the direction to the new point from the **FROM POINT**. Input types accepted:

1. Bearing – The real number entered is interpreted based on the current [angle unit](#) and [direction reference](#) user settings.
2. Any of the standard [directions](#) input options.

### 'Distance' Field

This field requires the distance to the new point from the **FROM POINT**. Input types accepted:

1. A distance – The number entered is used as the distance.
2. Any of the standard [distances](#) input options.

### 'Offset' Field

This field accepts a perpendicular offset value from the line of direction. A positive offset is to the right while a negative offset is to the left. This field accepts the same types of inputs as the [Distance](#) field.

## Point Traverse – Angle Right

**Point Traverse – Angle Right** is like [Point Traverse - Standard](#) with differences as noted below.

### 'Backsight' Field

This field requires an existing point number to use as the backsight point.

### 'Angle Right' Field

This field requires a real number angle turned right (clockwise) from the Backsight.

Point Traverse – 4 R		
From Point:	<input type="text" value="6"/>	Std
Backsight:	<input type="text" value="5"/>	
Angle Right:	<input type="text" value="74°25'00"/>	4 R
Distance:	<input type="text" value="50.000m"/>	
Offset:	<input type="text" value="0.000m"/>	Plus
Mode:	<input type="text" value="Traverse"/>	Curve
Perpendicular Offset (+Right, -Left)		
<input type="button" value="Edit"/>		<input type="button" value="Cancel"/> <input type="button" value="Calc"/>

## Point Traverse – Plus

**Point Traverse - Plus** is a complete COGO solution with **Inverse** and **Intersection** capabilities.

### 'From Point' Screen

The **From Point** input screen prompts the user to input a point number to use as a starting point for further calculations. Input types accepted:

1. An existing point number – The program ensures the point exists.
2. A non-existing point number – The user may enter a point number that has not yet been stored in the database. An option to create the point will be presented.
3. Two point numbers in the format "From..To" – Calculate a point inverse between two points in the job. The **From Point** input screen is re-displayed after this input type is processed. For example, input **1..2** to calculate the inverse from Point 1 to Point 2.
4. Three point numbers in the format "Start..End..Offset" – Calculate a point to line inverse by entering the baseline start and end points and the offset point. The **From Point** input screen is re-displayed after this input type is processed. For example, input **1..2..3** to calculate the offset of Point 3 from the line defined by points 1 and 2.
5. Three point numbers in the format "BC+CC+EC" – Calculate a curve inverse, direction 'right', by entering the beginning of curve, curve center and end of curve points separated by the '+' character.

Point Traverse – Plus		
From Point:	<input type="text" value="11"/>	Std
Mode:	<input type="text" value="Traverse"/>	4 R
Offsets:	<input type="text"/>	Plus
Choose Traverse or Sideshot Mode		
<input type="button" value="Choose"/>		<input type="button" value="Cancel"/> <input type="button" value="OK"/>

The **From Point** input screen is re-displayed after this input type is processed. For example, input **1+2+3** to inverse a curve connecting Point 1 and Point 3 in a clockwise direction with curve center (radius point) at Point 2.

6. Three point numbers in the format “BC-CC-EC” – Calculate a curve inverse, direction ‘left’, by entering the beginning of curve, curve center and end of curve points separated by the ‘-’ character. The **From Point** input screen is re-displayed after this input type is processed. For example, input **1-2-3** to inverse a curve connecting Point 1 and Point 3 in a counter clockwise direction with curve center (radius point) at Point 2.

### The Menu

While editing the From Point, the menu updates to show these options:

**Browse** Opens the Point Database browser where the user can select a point from the list.

### Offsets

Toggle to enable offset fields in the Direction Input screens.

### ‘Bearing 1’ Screen

This screen prompts the user to input the bearing to the new point from the **FROM POINT**. Input types accepted:

1. Bearing – The real number entered is interpreted based on the current **angle unit** and **direction reference** user settings and the next screen is displayed.
2. Any of the standard **directions** input options.
3. Leave blank, no input – Signals that the bearing to the new point is unknown, which leaves the possibility of a Distance-Bearing, or Distance-Distance intersection.

The screenshot shows a software interface titled "Point Traverse - Plus". It contains two input fields: "Bearing 1:" which is currently empty, and "Offset:" which contains the text "0.000m". Below these fields, there is a blue text label that reads "Direction from Point 1203 (Blank if unknown)". At the bottom of the screen, there is a menu bar with three buttons: "Edit", "Cancel", and "OK".

### The Menu

While editing the Direction, the menu updates to show these options:

**QB→B** **B→QB** Converts the input between quadrant bearings and full circle bearings. The appearance and action of this menu option varies depending on your **direction reference** setting.

**±180°** Reverse direction of the number in the command line by adding/subtracting 180° / 200g.

### Offset

When enabled, the offset field accepts a perpendicular offset distance from the **FROM POINT**.

## 'Distance 1' Screen

This screen prompts the user to input the distance to the new point from the **FROM POINT**. Input types accepted:

1. A distance – The number entered is used as the distance and the next screen is displayed.
2. Any of the standard **distances** input options.
3. Leave blank, no input – Signals that the distance to the new point is unknown, which leaves the possibility of a Bearing-Bearing or a Bearing-Distance intersection, provided that the **Bearing 1** input was given.

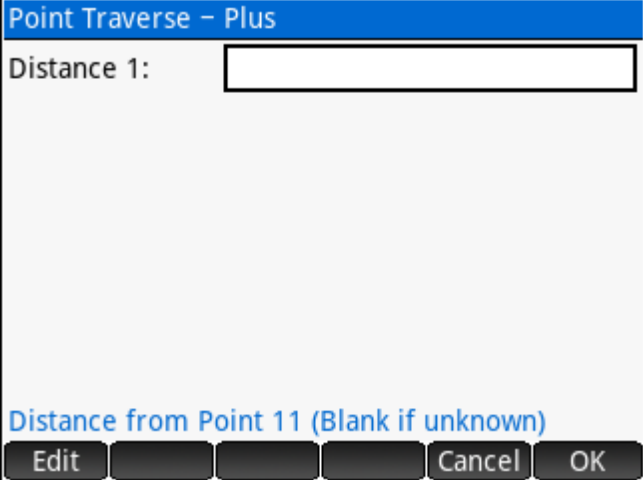

The screenshot shows a software interface titled "Point Traverse - Plus". It features a text input field labeled "Distance 1:". Below the input field, there is a blue text prompt: "Distance from Point 11 (Blank if unknown)". At the bottom of the screen, there is a row of buttons: "Edit", three unlabeled buttons, "Cancel", and "OK".

## The Menu

While editing the Distance, the menu updates to show these options:

**ft→m** or **m→ft** convert the input between metric and imperial units. The menu key varies depending on your **primary distance unit** setting.

## 'To Point' Screen

This screen accepts the point number of a second known point that an intersection calculation connects **to**.

This screen appears when either the **Bearing 1** or **Distance 1** inputs are unknown and left blank.

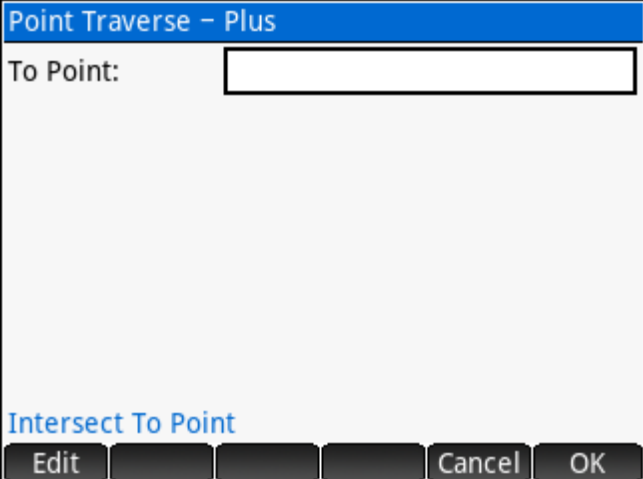

The screenshot shows a software interface titled "Point Traverse - Plus". It features a text input field labeled "To Point:". Below the input field, there is a blue text prompt: "Intersect To Point". At the bottom of the screen, there is a row of buttons: "Edit", three unlabeled buttons, "Cancel", and "OK".

### 'Bearing 2' Screen

This screen has two possible variations depending on whether **Bearing 1** or **Distance 1** is known. In both cases the screen prompts the user to enter the direction from the new point that is being calculated **TO** the second known point. This screen accepts the same input types as the **Bearing 1** screen.

The screenshot shows a screen titled "Point Traverse - Plus". It has two input fields: "Bearing 2:" which is empty, and "Offset:" which contains "0.000m". Below the fields is the text "Direction to Point 12 (Blank if unknown)". At the bottom are buttons for "Edit", "Cancel", and "OK".

### 'Distance 2' Screen

This screen prompts the user to enter the distance from the new point that is being calculated **TO** the second known point. This screen accepts the same input types as the **Distance 1** screen.

The screenshot shows a screen titled "Point Traverse - Plus". It has one input field: "Distance 2:" which is empty. Below the field is the text "Distance to Point 11 (Required)". At the bottom are buttons for "Edit", "Cancel", and "OK".

### 'Store Point' Screen

The screen displays the coordinates of the solved point and all the fields can be edited. The Point ID suggestion will always be next unused Point ID after the last stored point.

The screenshot shows a screen titled "Store Point". It has five input fields: "Point ID:" with the value "7", "Northing:" with "3010.863m", "Easting:" with "2032.000m", "Elevation:" with "0.000m", and "Description:" with "COGO". Below the fields is the text "Point Identifier". At the bottom are buttons for "Edit", "Cancel", and "Store".

### The Menu

While editing the Point ID, the menu updates to show these Point ID searching options:

**Low** Inserts the lowest unused point number into the command line.

**Next** Inserts the next lowest unused point number starting from the currently entered value.



## Curve Traverse

The **Curve Traverse** program allows the user to enter a beginning of curve (BC) point and a radius point, enter an arc length and choose the curve direction to solve the end of curve (EC) point.

### 'BC Point' Field

Enter the beginning of curve point number. A point number is automatically suggested for this input, usually the previously stored point, which can be useful when calculating multiple points along the same arc.

### 'Radial Point' Field

Enter the radius point number. The radius point input is remembered for the next use until the user quits the **Curve Traverse** program.

### 'Arc Length' Field

Enter the arc length of the curve.

### 'Direction' Field

Choose the curve direction, 'Right' is clockwise, while 'Left' is counter clockwise.

The standard STORE POINT screen follows valid input to store the EC point.

The screenshot shows the 'Curve Traverse' program interface. It features a blue title bar at the top. Below the title bar, there are four input fields: 'BC Point:' with the value '15', 'Radial Point:' with the value '14', 'Arc Length:' with the value '5.000m', and 'Direction:' with a dropdown menu showing 'Right (CW)'. To the right of these fields is a vertical column of buttons: 'Std', '4 R', 'Plus', and 'Curve'. At the bottom of the interface, there are four buttons: 'Choose', 'Cancel', and 'Calc'. The 'Curve' button is highlighted in blue.

## 4.2 Inverse Calculations

**Inverse Points, Inverse Curve, Inverse Angle, Inverse Point to Line, Inverse Point to Curve** and **Inverse Points to Alignment** are available options for inverting with point coordinates in the current project database.

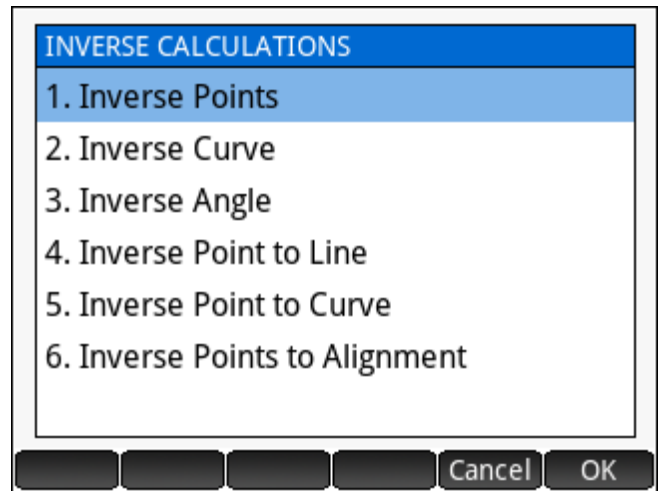

### Inverse Points

Inverse Points features four methods to inverse points: **Point to Point**, **Coordinates**, **Radial Ties**, and **Point Chain**.

#### Inverse Point to Point

Enter the **From Point** and **To Point** to calculate the inverse information between any two points in the job database.

The results screen displays the direction, horizontal distance, slope distance, slope grade, and coordinate differences between the two points.

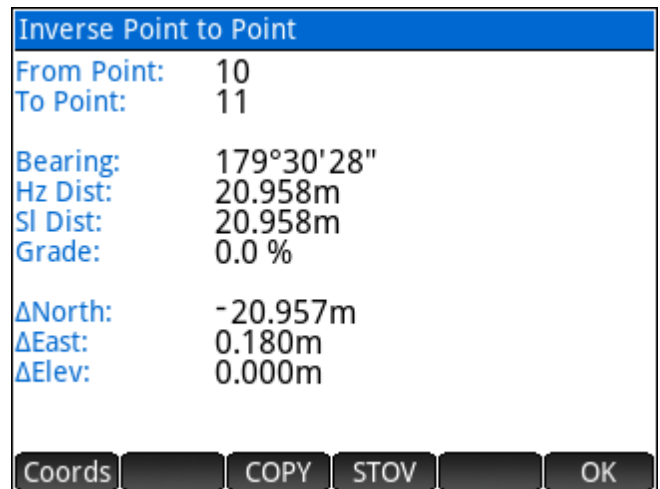
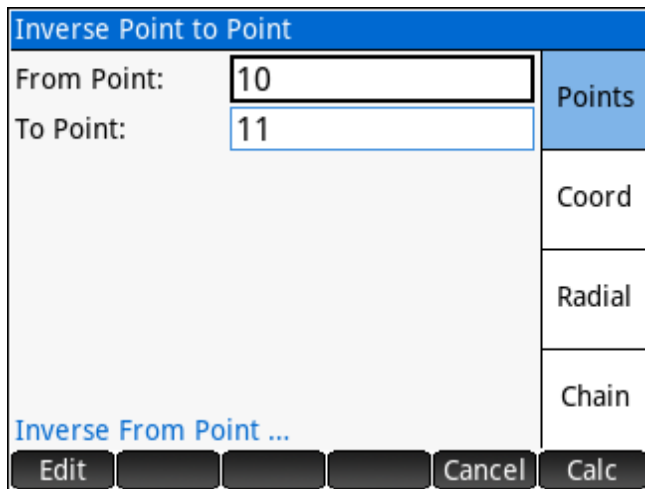

**Coords** Calculate Coordinates between the end points of the line (see next page for details).

## Line Coordinate Calculator

When the Point to Point Inverse is calculated, further calculations can be made between the end points of the line.

### By Station and Offset

Enter any Station and Offset to solve the coordinates. The station at the beginning or end of the line is required, then 3D coordinates are calculated at the specified station and offset. The solved positions can be stored in the project database with the **Store** option.

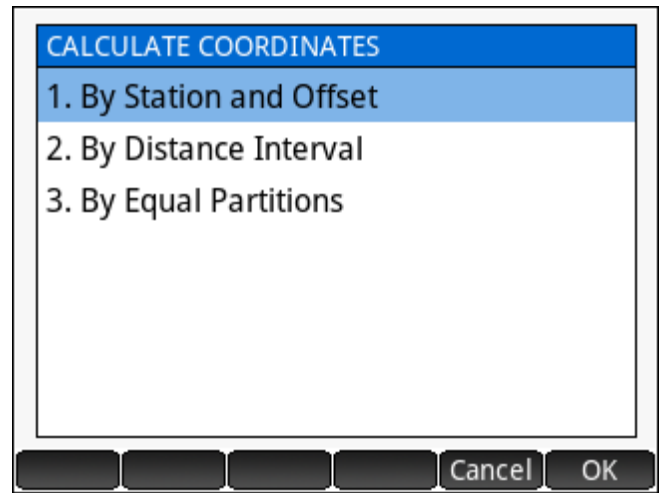

A menu titled "CALCULATE COORDINATES" with three options: "1. By Station and Offset", "2. By Distance Interval", and "3. By Equal Partitions". The first option is highlighted. At the bottom are buttons for "Cancel" and "OK".

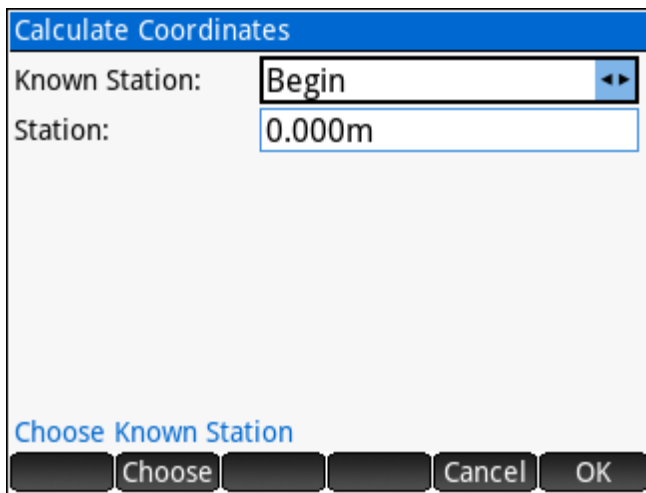

Calculate Coordinates dialog box. Fields: Known Station: **Begin**, Station: **0.000m**. Buttons: Choose Known Station, Choose, Cancel, OK.

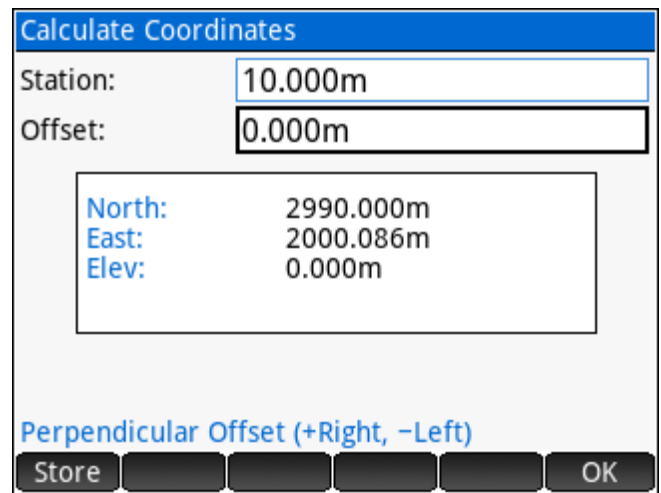

Calculate Coordinates dialog box showing results. Fields: Station: **10.000m**, Offset: **0.000m**. Results: North: 2990.000m, East: 2000.086m, Elev: 0.000m. Label: Perpendicular Offset (+Right, -Left). Buttons: Store, OK.

### By Distance Interval or Equal Partitions

Calculate multiple points at a specific interval or by dividing the line into equal partitions.

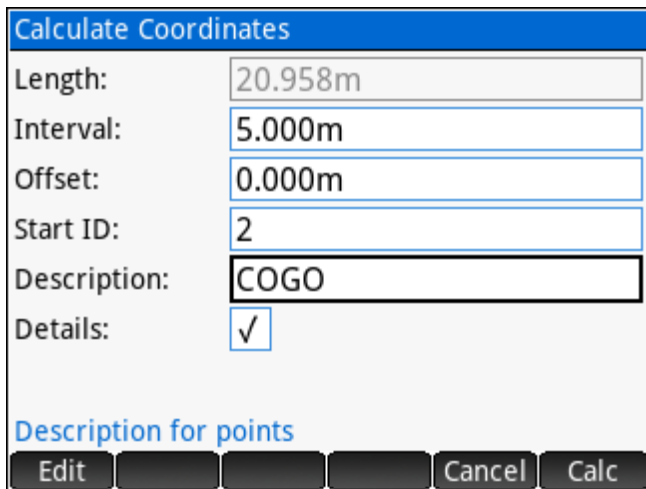

Calculate Coordinates dialog box. Fields: Length: **20.958m**, Interval: **5.000m**, Offset: **0.000m**, Start ID: **2**, Description: **COGO**, Details: . Label: Description for points. Buttons: Edit, Cancel, Calc.

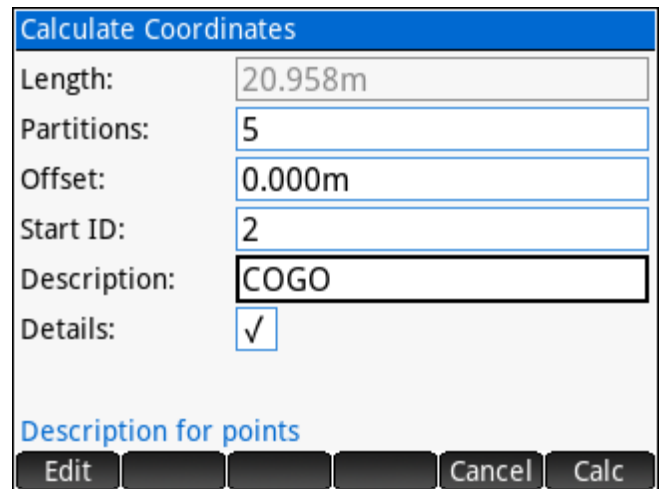

Calculate Coordinates dialog box. Fields: Length: **20.958m**, Partitions: **5**, Offset: **0.000m**, Start ID: **2**, Description: **COGO**, Details: . Label: Description for points. Buttons: Edit, Cancel, Calc.

## Inverse Coordinates

Enter the coordinates for two points to calculate the inverse.

Inverse Coordinates		
Northing 1:	1000.000m	Points
Easting 1:	1000.000m	
Elevation 1:	0.000m	Coord
Northing 2:	1250.000m	
Easting 2:	1375.000m	Radial
Elevation 2:	0.000m	
Elevation Coordinate		Chain
<input type="button" value="Edit"/> <input type="button" value="Cancel"/> <input type="button" value="Calc"/>		

Inverse Coordinates	
Bearing:	56°18'36"
Hz Dist:	450.694m
Sl Dist:	450.694m
Grade:	0.0 %
$\Delta$ North:	250.000m
$\Delta$ East:	375.000m
$\Delta$ Elev:	0.000m
<input type="button" value="Coords"/> <input type="button" value="COPY"/> <input type="button" value="STOV"/> <input type="button" value="OK"/>	

## Inverse Radial Ties

Enter the **From Point** and a **Range of Points** to calculate radial ties to that range of points.

Three pages of results are available.

- 2D Displays directions and horizontal distances.
- 3D Displays slope distances and grades.
- $\Delta$ XYZ Displays differences in coordinates.

Inverse Radial Ties		
From Point:	10	Points
Point(s):	11..15	
		Coord
		Radial
		Chain
Inverse From Point ...		
<input type="button" value="Edit"/> <input type="button" value="Cancel"/> <input type="button" value="Calc"/>		

Inverse Radial Ties			
From	To	Bearing	Hz Dist
10	11	179°30'28"	20.958m
10	12	190°57'34"	24.044m
10	13	260°47'59"	31.311m
10	14	278°24'44"	48.585m
10	15	278°24'44"	27.585m
<input checked="" type="radio"/> 2D <input type="radio"/> 3D <input type="radio"/> $\Delta$ XYZ <input type="button" value="OK"/>			

## Inverse Point Chain

Enter a **Range of Points** to calculate a series of Point to Point inverses, as a chain connecting the points.

Inverse Point Chain	
Point(s):	<input type="text" value="10..15"/>
	Points
	Coord
	Radial
	Chain
Point Range (#.#,#.#.#)	
Edit	Cancel
	Calc

Inverse Point Chain			
From	To	Bearing	Hz Dist
10	11	179°30'28"	20.958m
11	12	240°52'00"	5.439m
12	13	305°13'45"	32.242m
13	14	305°13'45"	21.000m
14	15	98°24'43"	21.000m
15	10	98°24'44"	27.585m

• 2D   3D   ΔXYZ   OK

## Inverse Curve

Inverse a Curve using a Radial Point or Three Points on the curve.

### Inverse Curve (Radial Point)

Enter the **Beginning of Curve Point**, the **Radius Point** and the **End of Curve Point**, and choose the **Curve Direction** to calculate the curve information.

The results screen displays the radius, deflection angle, arc length, chord length, tangent length, mid-ordinate length, external length, sector area, segment area and fillet area of the curve.

Inverse Curve (Radial Point)	
BC Point:	15
Radial Point:	14
EC Point:	13
Direction:	Right (CW) <span>↔</span>
Radial	
3 Pts	
Curve Direction	
<span>Choose</span> <span>Cancel</span> <span>Calc</span>	

Inverse Curve	
Curve:	15+14+13
Radius:	21.000m
Defl Angle:	26°49'02"
Arc:	9.829m
Chord:	9.740m 201°49'14"
Tangent:	5.006m
Mid-Ord:	0.572m
External:	0.588m
Sector Area:	103.204m <sup>2</sup>
Segment Area:	3.727m <sup>2</sup>
Fillet Area:	1.926m <sup>2</sup>
<span>Coords</span> <span>COPY</span> <span>STOV</span> <span>OK</span>	

### Inverse Curve (Three Point)

Enter the **Beginning of Curve Point**, a **Curve Point** and the **End of Curve Point** to calculate the curve information.

The program can determine if the curve direction is right or left. Following the result screen, an option is presented to store the radius point.

Inverse Curve (Three Point)	
BC Point:	14
Curve Point:	15
EC Point:	11
Radial	
3 Pts	
Beginning of Curve Point	
<span>Edit</span> <span>Cancel</span> <span>Calc</span>	

Inverse 3Pt Curve	
Curve:	14+15+11
Radius:	50.051m
Defl Angle:	67°46'22"
Arc:	59.203m
Chord:	55.811m 120°11'19"
Tangent:	33.615m
Mid-Ord:	8.501m
External:	10.241m
Sector Area:	1481.575m <sup>2</sup>
Segment Area:	322.113m <sup>2</sup>
Fillet Area:	200.903m <sup>2</sup>
<span>Coords</span> <span>COPY</span> <span>STOV</span> <span>OK</span>	

**Coords** Calculate Coordinates on the curve.

### Curve Coordinate Calculator

When the Point to Point Inverse is calculated, further calculations can be made between the end points of the line.

#### By Station and Offset

Enter any Station and Offset to solve the coordinates.

The station at the BC, PI, or EC of the curve is required, then 3D coordinates are calculated at the specified

station and offset. The solved positions can be stored in the project database with the **Store** option.

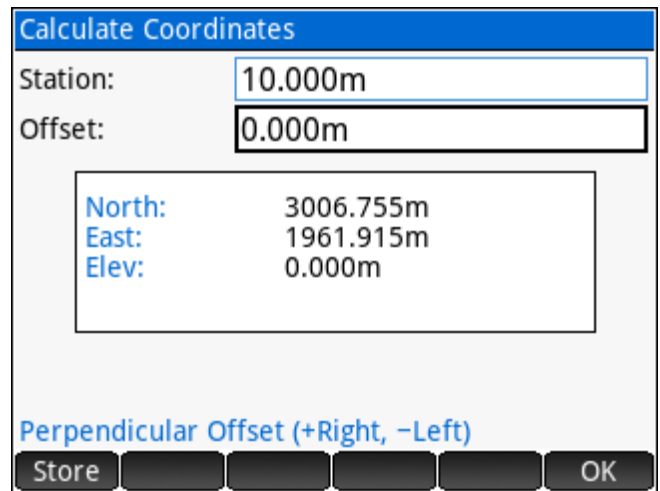
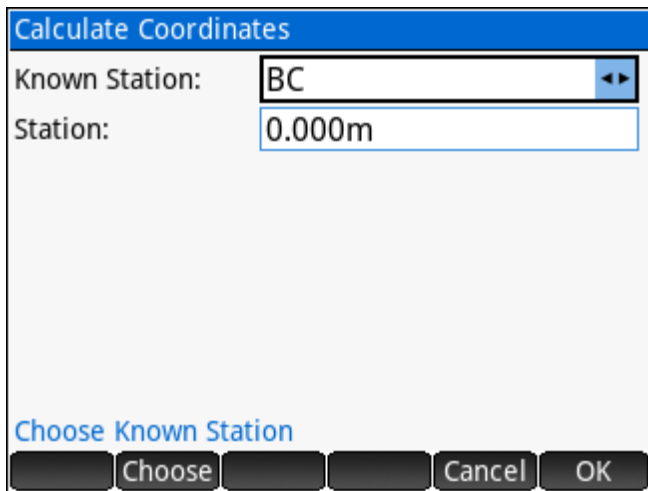
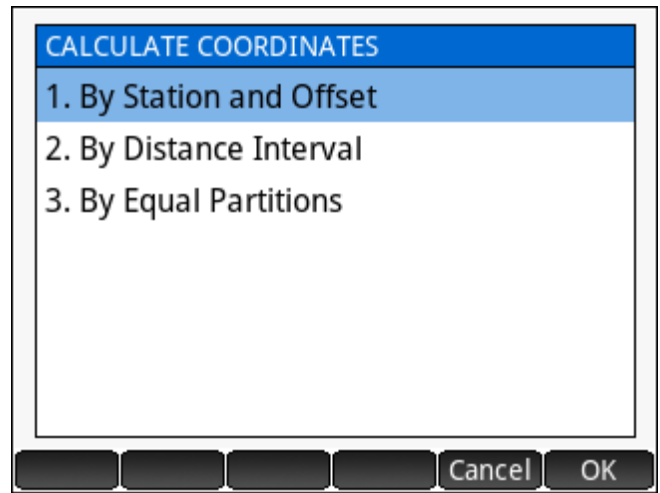

#### By Distance Interval or Equal Partitions

Calculate multiple points at a specific interval or by dividing the line into equal partitions.

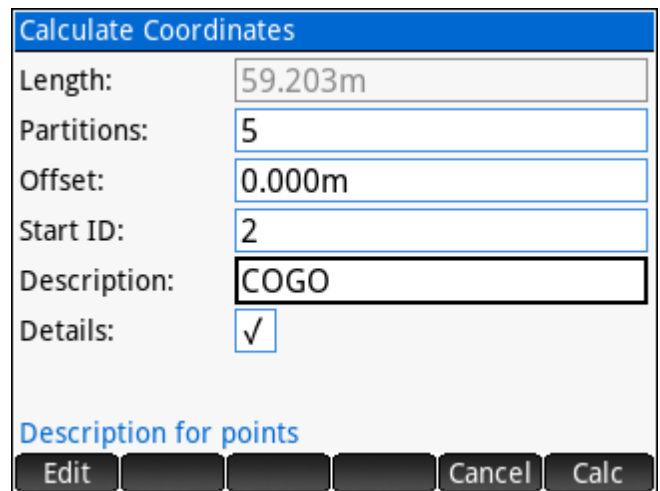
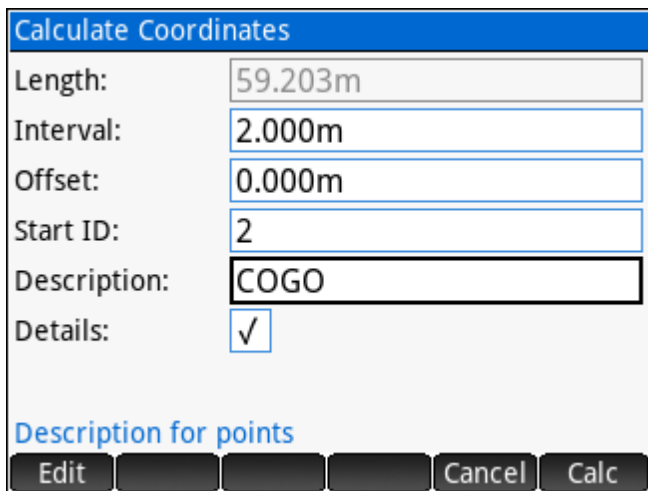

## Inverse Angle

Enter the **Occupy Point**, the **Backsight Point** and the **Foresight Point** to calculate the included angle. The results screen displays the angles turned right and left as well as the distances to the backsight and foresight points from the occupy point.

Inverse Angle	
Occupy:	12
Backsight:	11
Foresight:	10

Occupy Point (Vertex)

Edit [ ] [ ] [ ] Cancel OK

Inverse Angle	
Occupy:	12
Backsight:	11
Foresight:	10
Angle Right:	310°05'34"
Angle Left:	49°54'26"
To Backsight:	5.439m
To Foresight:	24.044m

[ ] [ ] COPY STOV [ ] OK

## Inverse Point to Line

Enter two points, **Baseline P1** and **Baseline P2**, to define a baseline and an **Offset Point** to calculate the perpendicular offset of the point to the line.

The results screen displays the offset from the baseline, Station 1 from **Baseline P1** to a point along the baseline that is perpendicular to the offset point, Station 2 to the same point from **Baseline P2**, the cut/fill to the baseline and the length, direction and the grade of the baseline.

Inverse Point to Line	
Offset Point:	13
Baseline P1:	14
Baseline P2:	15

Point offset from Baseline

Edit [ ] [ ] [ ] Cancel OK

Inverse Point to Line	
Offset Point:	13
Offset:	9.474m
Station 1:	18.741m
Station 2:	2.259m
Cut/Fill:	0.000m
Baseline:	14-15
Bearing:	98°24'43"
Hz Dist:	21.000m
Sl Dist:	21.000m
Grade:	0.0 %

[ ] [ ] COPY STOV [ ] OK



## Inverse Point to Curve

Enter a **Beginning of Curve Point**, a **Radius Point** and an **End of Curve Point**, choose a **Curve Direction**, and enter an **Offset Point** to calculate the perpendicular offset of the point to the curve.

The results screen displays the offset from the curve, Station 1 from the **Beginning of Curve** to a point along the curve that is perpendicular to the offset point, Station 2 to the same point from the **End of Curve**, the cut/fill to the curve, and the radius, length and grade of the curve.

**Inverse Point to Curve**

Offset Point:

BC Point:

Radial Point:

EC Point:

Direction:

**Curve Direction**

**Inverse Point to Curve**

Offset Point: 16

Offset: 0.041m

Station 1: 5.498m

Station 2: 4.331m

Cut/Fill: 0.000m

Curve: 15+14+13

Radius: 21.000m

Length: 9.829m

Grade: 0.0 %

## Inverse Points to Alignment

Select a pre-defined alignment and enter a single point or a range of points to inverse to the alignment. A maximum horizontal offset may be specified to ensure the point offset information is applied to the correct segment. A vertical offset constant may be entered to report cuts/fills to an offset from the vertical design. The vertical method may be set to template or centerline.

**Export** Results may be exported in **CSV** or **HTML** format.

**Inverse Points to Alignment**

Alignment:

Point(s):

Max Hz. Offset:

Vert. Offset:

Vert. Method:

**Maximum offset from centerline**

Point	Station	Offset	Cut/Fill
300	0+000.005	-7.013m	0.247m
301	0+000.006	-5.013m	0.221m
302	0+000.007	-0.013m	0.197m
303	0+000.008	4.988m	0.223m
304	0+000.009	6.988m	0.248m
305	0+009.996	-7.011m	0.136m
306	0+009.995	-5.010m	0.110m
307	0+009.994	-0.010m	0.086m
308	0+009.993	4.991m	0.111m

## 4.3 Intersections

The **Intersections** program can solve four types of intersections.

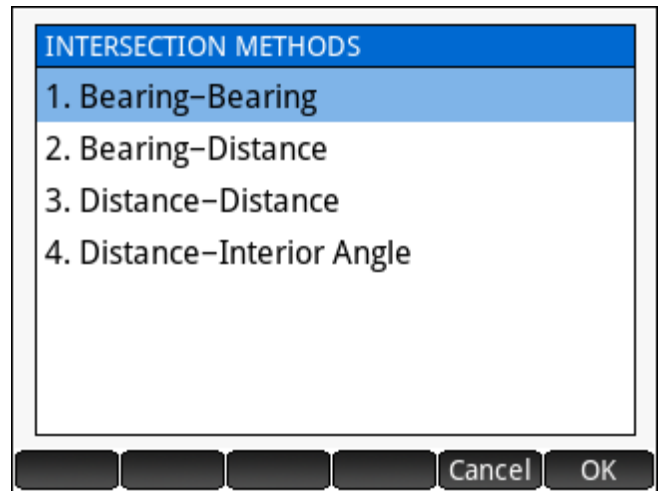

In the diagram shown, the '1<sup>st</sup> Point' and "2<sup>nd</sup> Point' points are always known points and the 'New Point' point can be calculated from the known information.

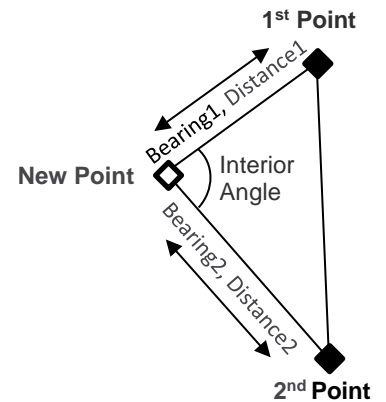

### Bearing-Bearing

A bearing-bearing intersection can be solved when **BEARING1** and **BEARING2** are known. Offsets may be entered for both direction inputs.

Bearing-Bearing Intersection		
First Point:	10	
Bearing:	225°47'00"	
Offset:	0.000m	
Second Point:	11	
Bearing:	325°43'00"	
Offset:	0.000m	
Perpendicular Offset (+Right, -Left)		
Edit	Cancel	OK

Store Point		
Point ID:	16	
Northing:	2991.748m	
Easting:	1991.519m	
Elevation:	0.000m	
Description:	COGO	
Point Identifier		
Edit	Cancel	Store

## Bearing-Distance

A bearing-distance intersection can be solved when **BEARING1** and **DISTANCE2** are known. This type of intersection usually has two possible solutions. The user is prompted to choose which of the two solutions is desired by selecting one of the two possible **DISTANCE1** solutions. A “No Solution” error indicates that the intersection is not possible with the data provided.

Bearing-Distance Intersection		
First Point:	10	
Bearing:	225°47'00"	
Offset:	0.000m	
Second Point:	11	
Distance:	15.376m	
<b>First Point</b>		
Edit	Cancel	OK

Store Point		
Point ID:	16	
Northing:	2991.747m	
Easting:	1991.519m	
Elevation:	0.000m	
Description:	COGO	
<b>Point Identifier</b>		
Edit	Cancel	Store

SOLUTION FROM POINT 10		
1.	225°47'00" 17.138m	
2.	225°47'00" 11.834m	
Cancel		OK

## Distance-Distance

A distance-distance intersection can be solved when **DISTANCE1** and **DISTANCE2** are known. This type of intersection usually has two possible solutions. The user is prompted to choose which of the two solutions is desired by selecting one of the two possible solutions from the first point.

Distance-Distance Intersection	
First Point:	10
Distance:	11.833m
Second Point:	11
Distance:	15.376m

First Point

Edit [ ] [ ] [ ] Cancel OK

SOLUTION FROM POINT 10	
1.	133°14'00" 11.833m
2.	225°46'57" 11.833m

[ ] [ ] [ ] [ ] Cancel OK

Store Point	
Point ID:	16
Northing:	2991.748m
Easting:	1991.519m
Elevation:	0.000m
Description:	COGO

Point Identifier

Edit [ ] [ ] [ ] Cancel Store

## Distance-Interior Angle

A distance-interior angle intersection can be solved when **DISTANCE1** and the **INTERIOR ANGLE** at the new point are known. This type of intersection can have up to 4 possible solutions. The user is prompted to choose the preferred solution.

Distance-Interior Angle Intersection		
First Point:	10	
Distance:	11.833m	
Second Point:	11	
Angle:	99°56'00"	
First Point		
Edit	Cancel	OK

SOLUTION FROM FIRST POINT		
1.	133°13'52" 11.833m	
2.	225°47'05" 11.833m	
Cancel		OK

Store Point		
Point ID:	16	
Northing:	2991.748m	
Easting:	1991.519m	
Elevation:	0.000m	
Description:	COGO	
Point Identifier		
Edit	Cancel	Store

## 4.4 Areas / Closures

Calculate an **Area by Points**, subdivide a desired area from an existing parcel using the **Sliding Bearing** or **Hinge Point** methods, check your Plan using the **Lot Closures** routine, or use the **Quick Closure** routine to quickly check the closure of a figure or to calculate missing dimensions.

### Area by Points

The **Area by Points** program calculates the area of a polygon when the points along the perimeter of the polygon are entered in sequence. The polygon can consist of straight segments and curves.

To enter straight segments:

1. Enter individual points separated by spaces. For example, **1 2 3 4 5 6**.
2. Enter a range of points in sequence and in numerical ascending order. For example, **1..6**.
3. Enter any combination of the above. For example, **1 3 9..15 18 20..29 33**.

To enter curves:

1. Curve 'Right' – Enter points separated by the '+' character so that the curve is defined by BC+CC+EC. For example, **1+2+3**.
2. Curve 'Left' – Enter points separated by the '-' character so that the curve is defined by BC-CC-EC. For example, **1-2-3**.
3. Compound curves and reverse curves – Enter each curve component separately so that each curve component is its own block of points, BC+CC+EC or BC-CC-EC, and each block is separated by a space. For example, **1+2+3 3-4-5** or **1+2+3 3+4+5**, etc.

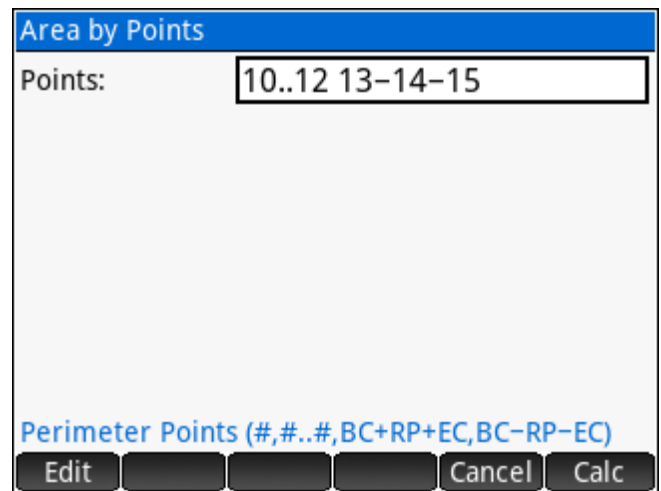
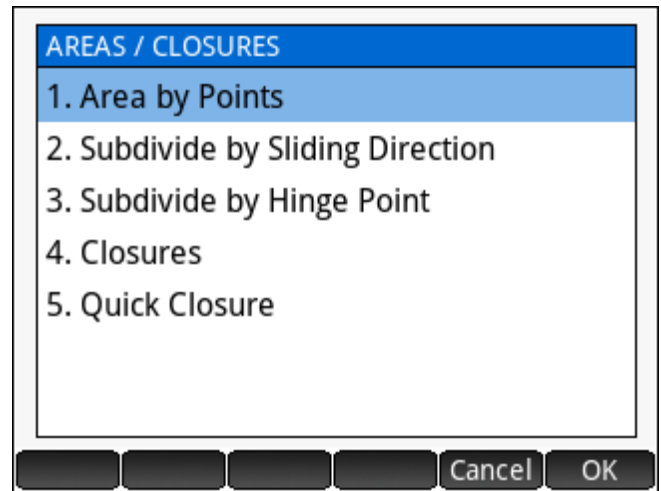

**NOTE:** An error occurs when the points provided as curve points do not actually define a curve, i.e. the radius differs by more than the [radius tolerance](#) setting.

Any mix of straight segments and curves is accepted. For example, an area with straight segments and a curve could be [10 11 12 13-14-15](#) which could also be entered as [10.12 13-14-15](#).

The area (square units and hectares/acres) and perimeter are displayed following a valid input. The program automatically determines the direction (clockwise or counter clockwise) the points were entered. The [primary distance unit](#) affects the results displayed.

**Export** Export a DXF File of the area calculated

**Cancel** Exit the Area by Pons program.

**OK** Return to the Input Form.

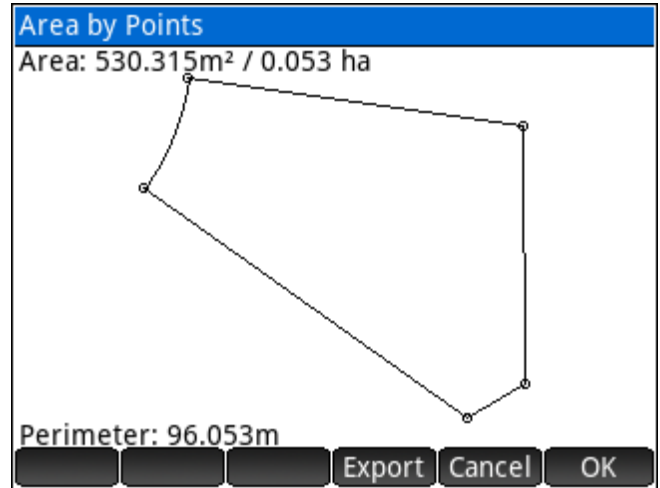

### Sample Coordinates

```
Point,Northing,Easting,Elevation,Description
10,3000.0000,2000.0000,0.0000,AREA
11,2979.0430,2000.1800,0.0000,AREA
12,2976.3950,1995.4290,0.0000,AREA
13,2994.9938,1969.0919,0.0000,AREA
14,3007.1076,1951.9380,0.0000,AREA_CC
15,3004.0355,1972.7121,0.0000,AREA
```

## Subdivide by Sliding Direction

Calculate a specified area by sliding a line of fixed bearing. For the diagram on the right, assume the known coordinates as listed and the fixed bearing line to be  $6^{\circ}10'35''$  with a desired area of  $100\text{m}^2$ . The program will calculate the coordinates for highlighted points 26 and 27 shown.

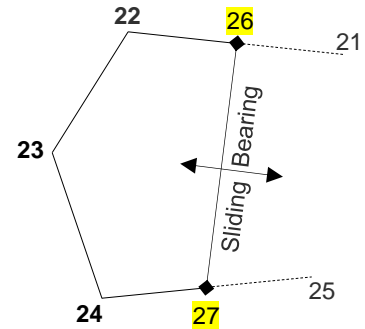

First, enter the points that define the fixed boundaries, in this example those points are 22, 23 and 24.

Next, enter the directions from the first and from the last point that you entered for the fixed points. Use any of the standard [directions](#) input options.

Next, enter the desired area and the direction of the sliding bearing.

The solution is displayed with the locations of the solution points marked as "A" and "B" on the plot.

**Export** Export a DXF File of the area subdivided.

**Cancel** Exit the Area Subdivision program.

**OK** Return to the Input Form.

A prompt provides the option to store the solution points.

Subdivide by Sliding Direction	
Fixed Points:	22 23 24
Bearing 1:	$95^{\circ}42'38''$
Bearing 2:	$84^{\circ}17'22''$
Desired Area:	100.000 Sq.m.
Bearing:	$6^{\circ}10'35''$
Points defining fixed boundaries	
<input type="button" value="Edit"/> <input type="button" value="Cancel"/> <input type="button" value="Calc"/>	

Subdivide by Sliding Direction	
Area: $100.000\text{m}^2 / 0.010\text{ ha}$	
Perimeter: 38.647m	
<input type="button" value="Export"/> <input type="button" value="Cancel"/> <input type="button" value="OK"/>	

## Sample Coordinates

Point	Northing	Easting	Elevation	Description
21	2100.000	1100.000	0.000	SLIDE
22	2101.000	1090.000	0.000	SLIDE
23	2096.000	1086.000	0.000	SLIDE
24	2089.000	1089.000	0.000	SLIDE
25	2090.000	1099.000	0.000	SLIDE



## Subdivide by Hinge Point

Calculate a specified area by swinging a line from a hinge point into another line of fixed bearing. For the diagram on the right, assume the known coordinates as listed and the direction from Point 35 to be parallel to the line 34-33 with a desired area of 180m<sup>2</sup>. The program will calculate the coordinates for highlighted point 36 shown.

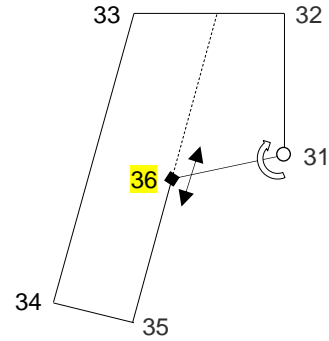

First, enter the points that define the fixed boundaries, **starting with the hinge point**. In this example those points are **31**, 32, 33, 34 and 35.

Next, enter the direction from the last fixed point followed by the desired area. Use any of the standard [directions](#) input options.

**Subdivide by Hinge Point**

Fixed Points:

Bearing 2:

Desired Area:

Choose area unit

The solution is displayed with the location of the solution point marked as “A” on the plot.

- Export a DXF File of the area subdivided.
- Exit the Area Subdivision program.
- Return to the Input Form.

A prompt provides the option to store the solution point.

**Subdivide by Hinge Point**

Area: 180.000m<sup>2</sup> / 0.018 ha

Perimeter: 64.632m

## Sample Coordinates

Point	Northing	Easting	Elevation	Description
31	120.000	220.000	0.000	HINGE
32	130.000	220.000	0.000	HINGE
33	130.000	210.000	0.000	HINGE
34	111.000	203.000	0.000	HINGE
35	109.000	208.000	0.000	HINGE

## Closures

Closures are associated with the active project at the time of creation, and multiple closures can be stored within each project.

### Closure Manager

The Closure Manager keeps track of the closures computed in the current project.

- New** Create a new Closure. The name and starting point coordinates are entered.
- Delete** Delete the selected closure. A confirmation prompt is displayed.
- Edit** Edit the name and starting point coordinates of the selected closure.
- Load** Load the selected closure for editing and calculating.

Default Closures	
Closure	Segments
SAMPLE	0

**New** **Delete** **Edit** **Cancel** **Load**

New Closure	
Name:	<input type="text" value="SAMPLE"/>
Start North:	<input type="text" value="5000.000m"/>
Start East:	<input type="text" value="5000.000m"/>

Enter a name for the closure

**Edit** **Cancel** **OK**

### Closure Editor

When a closure is loaded, the segments that have been defined are displayed.

- Edit** Edit the selected segment.
- Delete** Delete the selected segment. A confirmation prompt is displayed.
- Insert** Insert a segment above the selected segment.
- Calc** Calculate the Closure.
- Add** Add a segment to the Closure. Line and Curve segments can be added.

Closure SAMPLE		
Segment	Parameter 1	Parameter 2
1 Line	A 131°12'15"	D 93.389m
2 Line	A 25°54'55"	D 79.811m
3 Curve L	R 9.144m	L 16.076m
4 Curve R	R 187.054m	L 62.374m
5 Line	A 221°10'51"	D 65.192m

**Edit** **Delete** **Insert** **Calc** **Cancel** **Add**

## Add Segment

When adding a segment, the input form features two pages. One page takes input to add a Line and the other takes input to add a Curve. The input form continues in a loop until cancelled.

**Add Line Segment**

	↶ 45°	↷ 45°	<b>Line</b>
	↶ 90°	↷ 90°	
Bearing:	131°12'15"		<b>Curve</b>
Distance:	93.389m		
<b>Direction to New Point</b>			
Edit		Cancel	
OK			

**Add Curve Segment**

Direction:	Left (CCW)	<b>Line</b>
Known:	Bearing to Radial I	
Bearing:	295°54'55"	<b>Curve</b>
Radius:	9.144m	
Arc:	16.076m	
Defl Angle:	0°00'00"	
Chord:	0.000m	
<b>Deflection Angle</b>		
Edit		Cancel
OK		

The Closure Editor displays the segments with their key parameters once they are defined.

Closure SAMPLE		
Segment	Parameter 1	Parameter 2
1 Line	B 131°12'15"	D 93.389m
2 Line	B 25°54'55"	D 79.811m
3 Curve L	R 9.144m	L 16.076m
4 Curve R	R 187.054m	L 62.374m
5 Line	B 221°10'51"	D 65.192m

Edit Delete Insert Calc Cancel Add

## Delete Segment

Select a segment to delete and choose the menu option. A confirmation is required.

## Edit Segment

Select the segment to edit and choose the menu option. The current information is loaded for editing.

## Insert Segment

Select a segment and choose the menu option to insert a new segment before the selected segment.

## Closure Solution

When all the segments are defined, the **Calculate** option will display the results of the closure. The **Solution** page shows the numeric results, while the **Plot** page will draw the segments.

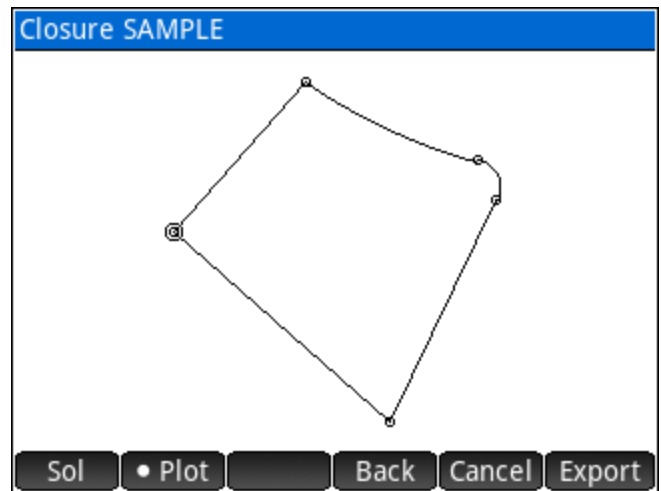
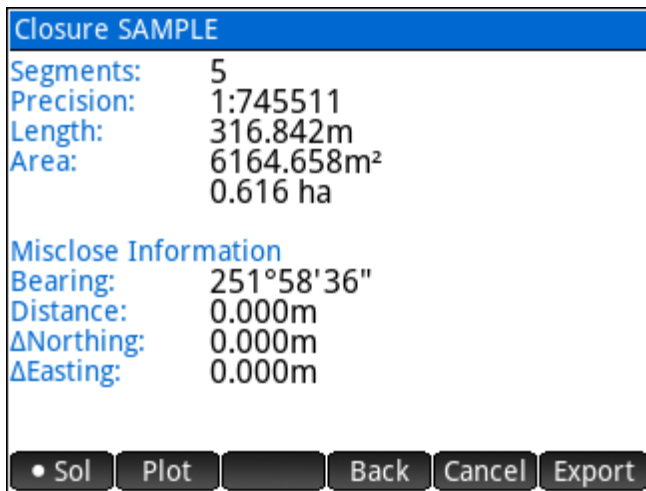

## Export Options

Export the closure results.

- ▶ **Add Closure Report to Log File** – Adds the current closure results to a **ClosureLOG.txt** file. With this option it is possible to have numerous closures reported in a single TEXT file for printing, etc.
- ▶ **Clear Log File** – Clears the ClosureLOG.txt file if it exists.
- ▶ **Export HTML Report** – Creates an HTML report of the closure. The user can enter a file name for the report, which can then be viewed in a web browser on a PC or Mac.
- ▶ **Export DXF File** – Creates a DXF file of the closure lines and curves. The user can enter a file name for the DXF file, which can then be viewed in a CAD program on a PC or Mac.
- ▶ **Store Point Coordinates** – Store the points that define the closure. Coordinates are calculated from the starting point coordinates for the closure. The user can enter a Starting Point ID and a descriptor for the points.

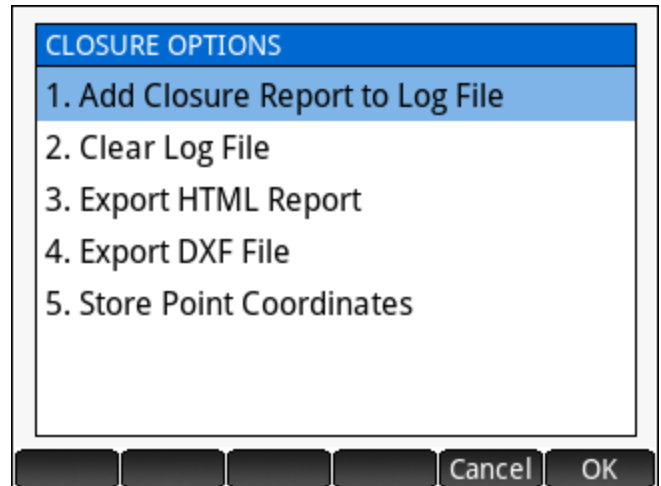

## Sample Closure Report

Enter the lot dimensions to calculate the lot closure as shown below. The most westerly corner was used as the starting point, then counter clockwise around the perimeter. Arbitrary coordinates 5000,5000 were assigned to the starting point.

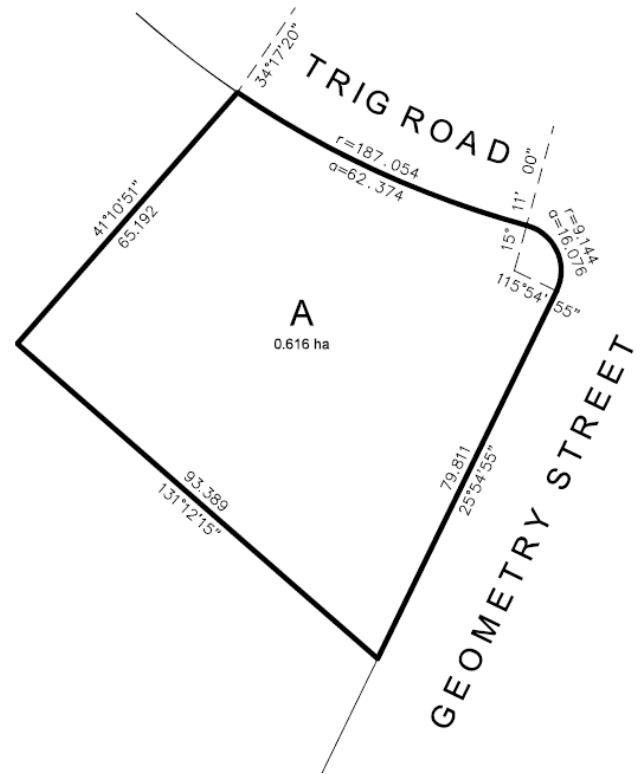

**Closure Report:** SAMPLE  
**Project:** Default  
**Date and Time:** December 21, 2019 - 5:58PM  
**Start Northing:** 5000.000m  
**Start Easting:** 5000.000m

Segment	Bearing	Length	End Northing	End Easting
1 Line	131°12'15"	93.389m	4938.481m	5070.263m
2 Line	25°54'55"	79.811m	5010.266m	5105.144m
3 Curve Left	335°32'59"	14.084m	5023.087m	5099.314m
- Radial Direction:	295°54'55"			
- Radius Length:	9.144m			
- Arc Length:	16.076m			
4 Curve Right	294°44'10"	62.085m	5049.066m	5042.925m
- Radial Direction:	15°11'00"			
- Radius Length:	187.054m			
- Arc Length:	62.374m			
5 Line	221°10'51"	65.192m	5000.000m	5000.000m

**Precision:** 1:745511  
**Length:** 316.842m  
**Area:** 6164.658m<sup>2</sup> / 0.616 ha  
**Misclose Bearing:** 251°58'36"  
**Misclose Distance:** 0.000m  
 - Northing: 0.000m  
 - Easting: 0.000m

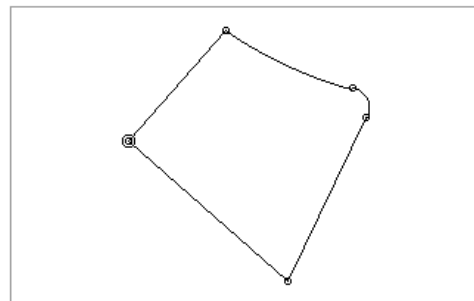

## Quick Closure

A **Quick Closure** is created by entering the known dimensions of the sides of a figure. There are no points or coordinates required and the results are not stored; it is optimized for quick entry and ease of use.

A closure may have one or two missing dimensions, which will be calculated whenever possible.

Curved segments may also be entered by specifying a chord distance and curve radius.

Examples will be used to illustrate the methods and results obtained.

### Example 1 – Closure with all dimensions known

The **Quick Closure** routine immediately opens to an input screen, prompting for the direction of the first line.

The entered values of the previous input are displayed for verification.

The menus provide the standard tools for working with [direction](#) and [distance](#) inputs.

Enter each direction and distance as prompted, then **Calc** after entering the fifth and final distance.

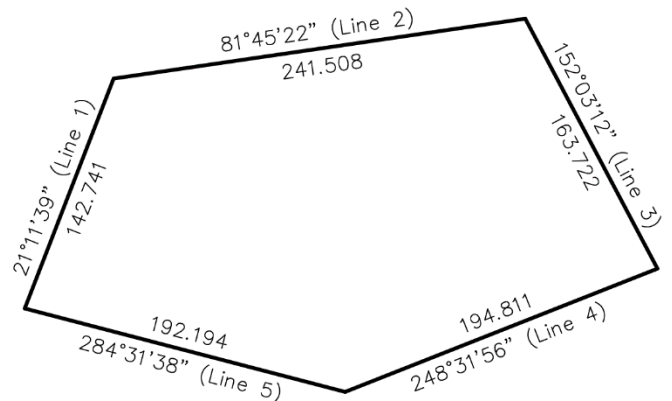

**Quick Closure**

Continue data entry until complete.  
Press ENTER for any unknown component.

Use [Calc] to finish.

**Bearing 1:**

21.1139

QB→B ±180° Calc Cancel OK

**Quick Closure**

Continue data entry until complete.  
Press ENTER for any unknown component.

Line 1:  
21°11'39"

**Distance 1:**

142.741

ft Curve Cancel OK

The results are displayed when finished. The first page of the results shows the solution with figure details and misclose information. A second page plots the figure geometry on the screen.

The menu:

- Sol      Sets the solution page current.
- Adjust      Sets the adjusted solution page current.
- Plot      Sets the plot page current.
- Exit      Exit the **Quick Closure** routine and return to the main menu.
- OK      Start a new closure.

NOTE: The adjusted solution is shown only when an adjustment is possible. The adjusted length and area are displayed.

**Quick Closure Results**

Segments: 5  
 Precision: 1:837045  
 Length: 934.976m  
 Total Length: 934.977m  
 Area: 53463.881m<sup>2</sup>  
           5.346 ha

Misclose Information

Bearing: 316°25'29"  
 Distance: 0.001m  
 ΔNorthing: 0.001m  
 ΔEasting: -0.001m

Sol    Adjust    Plot    Exit    OK

**Quick Closure Results**

Segments: 5  
 Length: 934.976m  
 Area: 53463.689m<sup>2</sup>  
           5.346 ha

Sol    Adjust    Plot    Exit    OK

**Quick Closure Results**

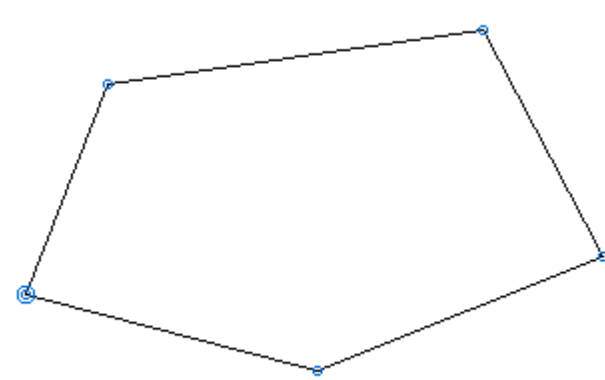

Sol    Adjust    Plot    Exit    OK

### Example 2 – Closure with missing dimensions

Enter the dimensions of the first two lines, and the direction of the third line. When prompted to enter the Distance 3 and 4 inputs;

simply leave them blank and press .

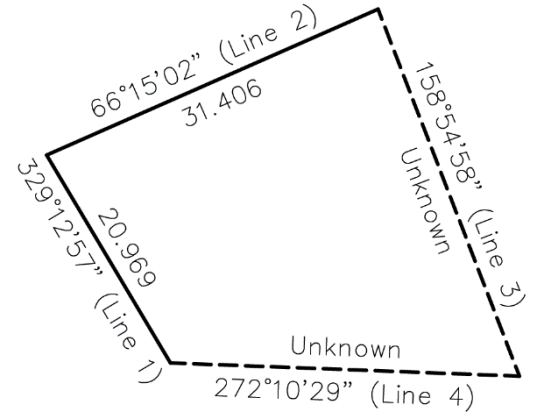

**Quick Closure**

Continue data entry until complete.  
Press ENTER for any unknown component.

Line 3:  
158°54'58"

Distance 3:

ft   Curve   Cancel   OK

The result in this case does not show a misclose. The calculated values of the missing dimensions are shown.

**Quick Closure Results**

Segments: 4  
Length: 116.772m  
Area: 801.384m<sup>2</sup>  
0.080 ha

Distance 3: 34.095m  
Distance 4: 30.301m

• Sol   Plot   Exit   OK

**Quick Closure Results**

Sol   • Plot   Exit   OK



### Example 3 – Closure with curve

Enter the dimensions for the first three lines, and the direction of the fourth line (chord). When prompted to enter Distance 4, use the **Curve** key on the menu to specify that a chord distance is being entered.

After the chord distance is entered; a prompt will ask for the radius of the curve. Enter a **positive** radius value if the curve follows a clockwise direction and enter a **negative** radius value if the curve follows a counter clockwise direction. In this case it is a clockwise direction, therefore a positive radius.

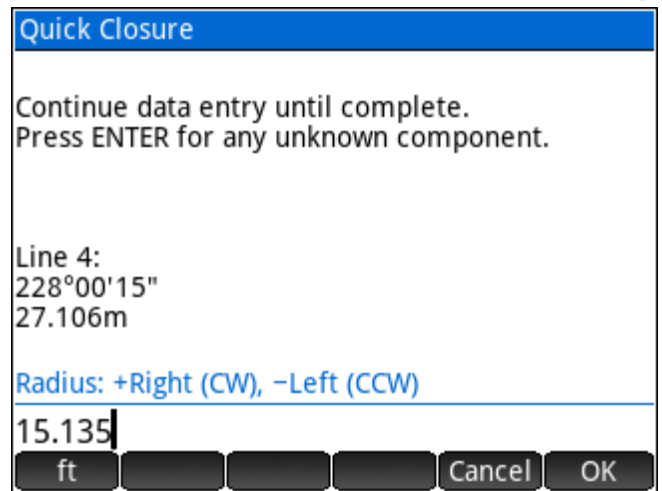
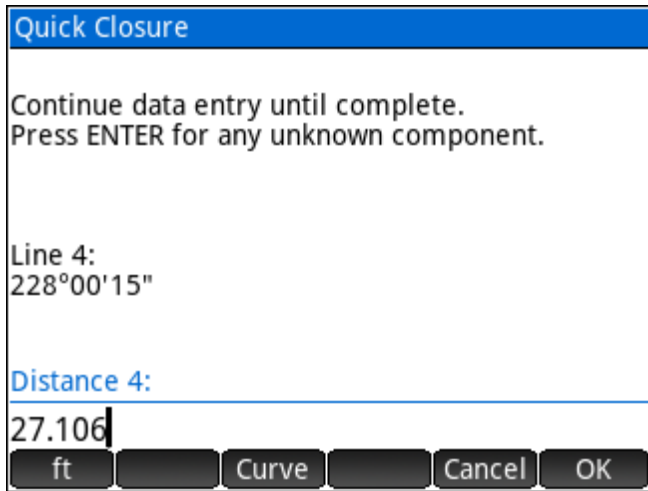
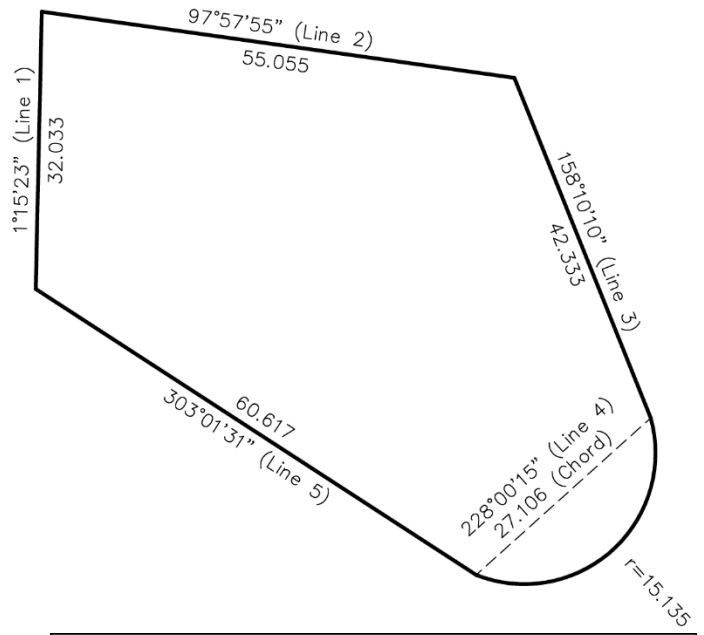

Enter the dimensions for the final line and then **Calc** to finish.

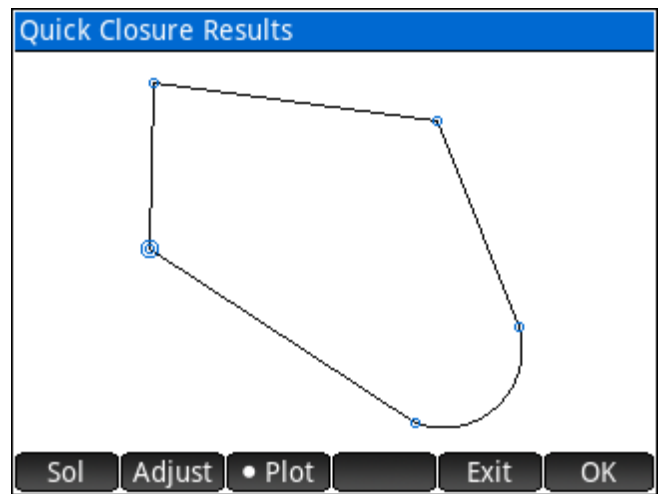
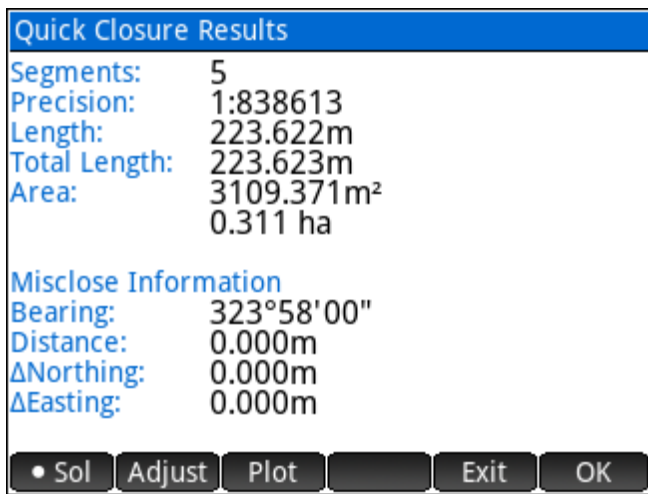

## 4.5 Fit Points

The **Fit Points** program consists of:

1. Best fit points to **Straight Line**, linear regression.
2. Best fit points to **Circular Curve**, like linear regression but fits points to a circular curve.
3. Solve the position of a lost corner using the **Double Proportionate Method**.
4. Solve the position of a lost corner using the **Irregular Boundary Adjustment Method**.
5. Solve the positions of lost angle points using the **Grant Boundary Adjustment Method**.

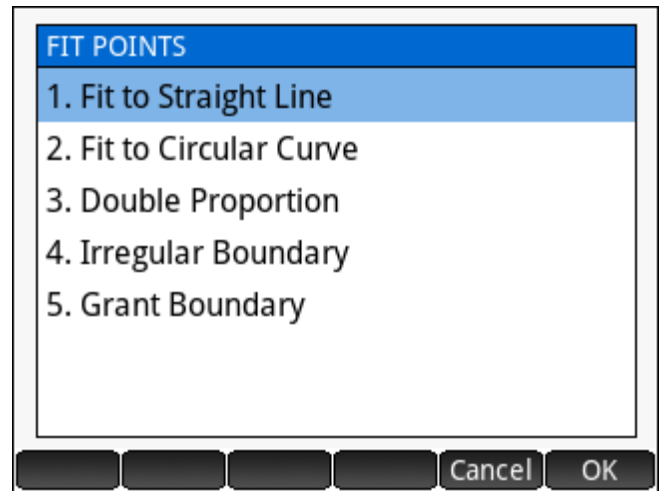

### Fit to Straight Line

Enter a series of points to compute the least squares straight line that best fits the points. Enter point numbers using any of the [point numbers](#) input options.

An un-weighted linear regression method that minimizes X and Y residuals simultaneously is used to calculate the line.

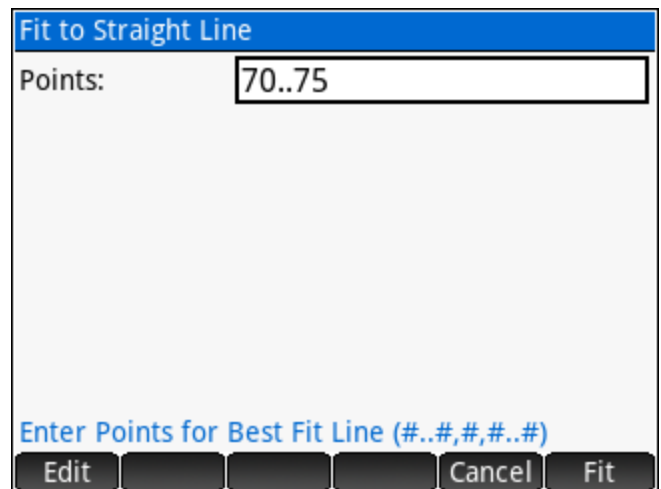

The direction and Y-Intercept of the line, the correlation coefficient (a value between -1 and 1), and the point offsets standard deviation are computed and displayed.

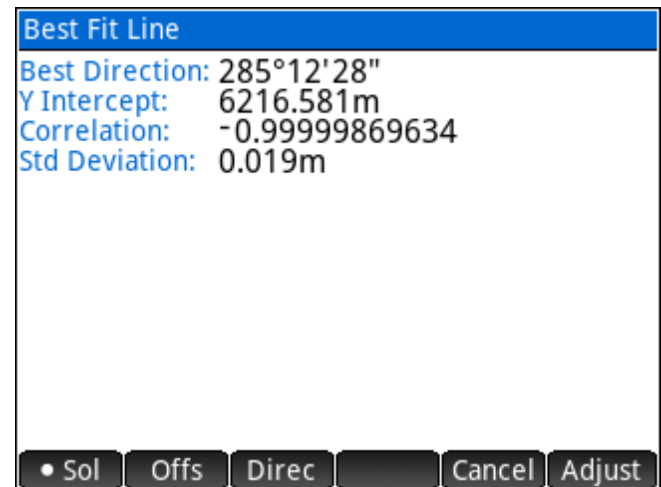

## The Menu

- Sol** Displays the solution details.
- Offs** Displays the perpendicular offsets to the line for each point used in the computation.
- Direc** Option to enter a direction constraint for the line or use the best fit direction. The solution details page indicates whether a **Best Direction** or **Fixed Direction** is in effect.
- Use -** **Use +** While viewing the perpendicular offsets, toggle whether the selected point will be used for the calculation.

Best Fit Line		
Point	Offset from Line	Use
70	0.010m	Yes
71	0.012m	Yes
72	-0.040m	Yes
73	0.002m	Yes
74	0.015m	Yes
75	0.001m	Yes

Sol • Offs Direc Use - Cancel Adjust

Proceeding with the adjustment provides the option to overwrite the existing points or to create new points.

Points are shifted perpendicular to the best-fit line to minimize the shift.

## Sample Coordinates

```
Point,Northing,Easting,Elevation,Description
70,5142.364,3951.682,0.000,FIT_LINE
71,5126.301,4010.781,0.000,FIT_LINE
72,5122.959,4022.875,0.000,FIT_LINE
73,5119.064,4037.366,0.000,FIT_LINE
74,5109.751,4071.672,0.000,FIT_LINE
75,5105.428,4087.524,0.000,FIT_LINE
```

## Fit to Circular Curve

The main purpose of this program is to calculate the radius and the coordinates of the radius point of the least squares circle that best fits a series of points. When providing points along one or both tangents, the program will also solve the BC and/or EC point coordinates.

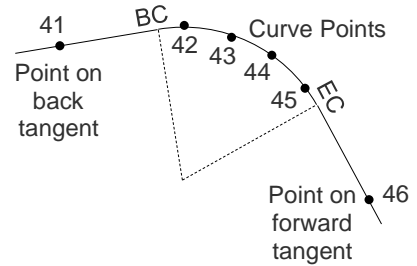

In the input form, enter a series of points along the curve to compute the circle that best fits the points. Enter point numbers using any of the [point numbers](#) input options.

**Optional:** Also enter points on the Tangent In/Out to compute the BC/EC points. If specifying tangent points, it is important to select the correct curve direction Right/Left.

The curve solution displays the computed radius, the radius standard deviation, the coordinates of the radius point, and if applicable, the bearings of the back and forward tangents.

**Fit to Circular Curve**

Points:	<input type="text" value="42..45"/>
Tangents?	<input checked="" type="checkbox"/>
Tangent In:	<input type="text" value="41"/>
Tangent Out:	<input type="text" value="46"/>
Direction:	<input type="text" value="Right (CW)"/>

**Curve Direction**

Choose
Cancel
Fit

**Best Fit Curve**

Best Radius:	3209.766m
Std Deviation:	0.020m
Radial North:	4053.992m
Radial East:	5587.375m
Tangent In:	105°14'32"
Tangent Out:	163°00'36"
Defl Angle:	57°46'04"
Arc:	3236.209m
Chord:	3100.868m
Tangent:	1770.710m

• Sol
Offs
Radius
Cancel
Adjust

## The Menu

- Sol** Displays the solution details.
- Offs** Displays the radial offsets to the curve for each point used in the computation.
- Radius** Option to enter a radius constraint for the curve or use the best fit radius. The solution details indicate whether a **Best Radius** or **Fixed Radius** is in effect.
- Use -** **Use +** While viewing the radial offsets, toggle whether the selected point will be used for the calculation.

Best Fit Curve		
Point	Offset from Curve	Use
42	0.009m	Yes
43	-0.026m	Yes
44	0.028m	Yes
45	-0.010m	Yes

**Sol** **• Offs** **Radius** **Use -** **Cancel** **Adjust**

Proceeding with the adjustment provides the option to overwrite the existing points or to create new points.

Prompts will be displayed to choose whether to store the Origin Point, and if possible; the BC and EC points.

Points are shifted radially to the best-fit curve to minimize the shift.

## Sample Coordinates

```
Point,Northing,Easting,Elevation,Description
41,7444.140,5354.860,0.000,FIT_CURVE
42,6947.930,6975.820,0.000,FIT_CURVE
43,6572.600,7577.110,0.000,FIT_CURVE
44,6071.290,8084.030,0.000,FIT_CURVE
45,5542.000,8431.380,0.000,FIT_CURVE
46,4268.900,8877.960,0.000,FIT_CURVE
```

## Double Proportion

“The term ‘double proportionate measurement’ is applied to a new measurement made between four known corners, two each on intersecting meridional and latitudinal lines, for the purpose of relating the cardinal equivalent intersection to both.” (Page 166, BLM Manual of Surveying Instructions 2009).

The **Double Proportion** program solves this type of problem by accepting point numbers for the four known corners, and the record measurements to the lost corner.

The first input form requires existing point numbers of the corners to the north, east, south and west of the lost corner.

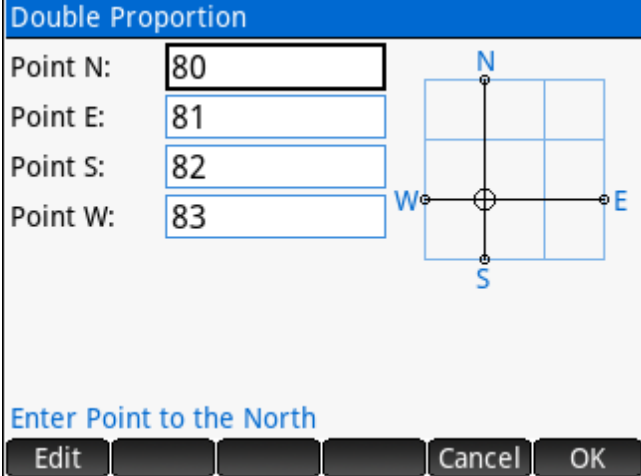

The screenshot shows a software window titled "Double Proportion". On the left, there are four input fields: "Point N:" with value "80", "Point E:" with value "81", "Point S:" with value "82", and "Point W:" with value "83". To the right is a diagram of a 3x3 grid with a central point marked with a circle and a cross. The cardinal directions are labeled: "N" at the top, "S" at the bottom, "W" on the left, and "E" on the right. At the bottom of the window, there is a blue prompt "Enter Point to the North" and a row of buttons: "Edit", a blank button, a blank button, "Cancel", and "OK".

The second input form requires the **record** bearings and distances to the known corners west and east of the lost corner.

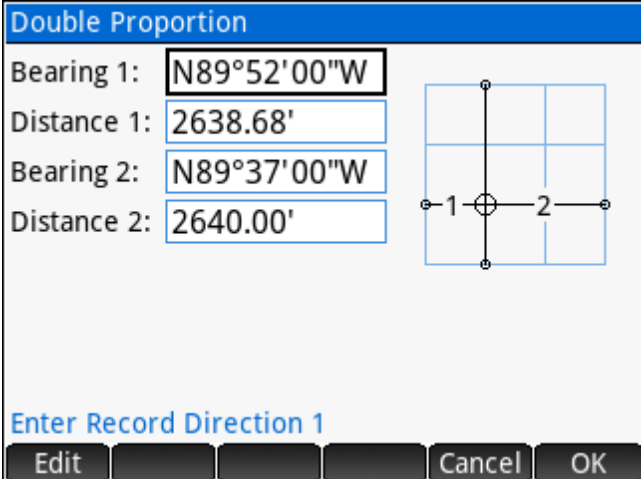

The screenshot shows a software window titled "Double Proportion". On the left, there are four input fields: "Bearing 1:" with value "N89°52'00\"W", "Distance 1:" with value "2638.68'", "Bearing 2:" with value "N89°37'00\"W", and "Distance 2:" with value "2640.00'". To the right is a diagram of a 3x3 grid with a central point marked with a circle and a cross. The cardinal directions are labeled: "N" at the top, "S" at the bottom, "W" on the left, and "E" on the right. The west and east sides of the grid are labeled with "1" and "2" respectively. At the bottom of the window, there is a blue prompt "Enter Record Direction 1" and a row of buttons: "Edit", a blank button, a blank button, "Cancel", and "OK".

The third input form requires the **record** bearings and distances to the known corners north and south of the lost corner.

The solution displays the coordinates of the calculated corner point, and the dimensions to the four known corners.

The option to store the calculated corner point is provided upon completion.

Sample Coordinates

```
Point,Northing,Easting,Elevation,Description
80,18000.000,13000.000,0.000,DP_NORTH
81,12686.799,16151.626,0.000,DP_EAST
82,10047.468,13460.294,0.000,DP_SOUTH
83,12714.524,10834.089,0.000,DP_WEST
```

## Irregular Boundary Adjustment

Irregular boundaries are the result of boundaries surveyed from opposite directions, or piecemeal surveys where resulting boundaries are not straight lines. “In order to restore one or more lost corners or angle points on such irregular exterior, a retracement between the nearest known corners is made on the record courses and distances to ascertain the direction and length of the closing distance. A position is calculated for each lost corner or angle point at the record position.” (Page 174, BLM Manual of Surveying

Instructions 2009) A combination of single proportion and compass rule is then used to re-establish the lost corner. The direction (East-West or North-South) determines how the adjustment is performed.

The **Irregular Boundary** program prompts for the direction of the line, and then the first input form requires the point numbers for the surveyed points (W + E, or N + S).

The screenshot shows a software menu titled "IRREGULAR BOUNDARY" in a blue header. Below the header, there are two menu items: "1. West-East Direction" and "2. North-South Direction". The second item is highlighted with a blue background. At the bottom of the screen, there are several buttons, including "Cancel" and "OK".

The screenshot shows an input form titled "Irregular Boundary" with a blue header. It contains two input fields: "Point N:" with the value "86" and "Point S:" with the value "85". To the right of these fields is a diagram of a 3x3 grid with a vertical line passing through the center. The top of the line is labeled "N" and the bottom is labeled "S". Below the grid, the text "Enter Point to the North" is displayed. At the bottom of the screen, there are buttons for "Edit", "Cancel", and "OK".

The second input form requires the **record** dimensions to the corners on either side of the lost corner.

The screenshot shows an input form titled "Irregular Boundary" with a blue header. It contains four input fields: "Bearing 1:" with the value "N1°22'00\"E", "Distance 1:" with the value "2641.32'", "Bearing 2:" with the value "N1°45'00\"W", and "Distance 2:" with the value "2535.72'". To the right of these fields is a diagram of a 3x3 grid with a vertical line passing through the center. The top of the line is labeled "1" and the bottom is labeled "2". Below the grid, the text "Enter Record Direction 1" is displayed. At the bottom of the screen, there are buttons for "Edit", "Cancel", and "OK".



The solution displays the coordinates of the calculated corner point, and the dimensions to the two known corners.

The option to store the calculated corner point is provided upon completion.

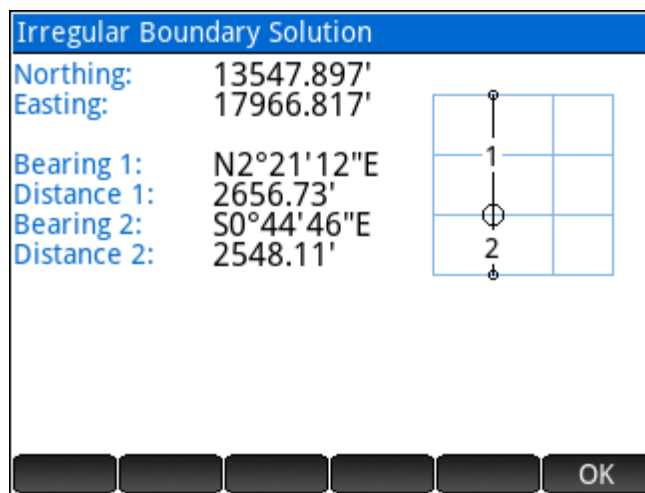

### Sample Coordinates

```
Point,Northing,Easting,Elevation,Description
85,11000.000,18000.000,0.000,IB_SOUTH
86,16202.385,18075.912,0.000,IB_NORTH
```

## Grant Boundary Adjustment

*“In many of the States there are irregular grant and reservation boundaries that were established prior to the public rectangular surveys. In these cases, the township and section lines are regarded as the closing lines. The grant boundary field notes may call for natural objects, but these are often supplemented by metes-and-bounds descriptions. The natural calls are ordinarily given precedence then the existent angle points of the metes-and-bounds survey. The lost angle points are then restored by uniformly orienting the record courses to the left or right and adjusting the lengths of the lines on a constant ration.” (Page 176, BLM Manual of Surveying Instructions 2009)*

The **Grant Boundary** program requires a series of points that define the grant boundary, starting with a known (found) point followed by calculated points using **record** dimensions. The first field asks for these points. The second field asks for a **Closing Point**, which is a found original point representing the last calculated point that was entered. The spatial difference between the closing point and the last calculated point determines the adjustment parameters.

The calculated rotation and scale are displayed on the results screen.

A choice is presented to adjust the record points.

Proceeding with the adjustment provides the option to overwrite the existing points or to create new points.

Grant Boundary

Record Points: 90..98

Closing Point: 99

Points calculated from Record (#..#,#, #..#)

Edit Cancel OK

Grant Boundary Solution

Rotation: 1°13'30"

Scale Factor: 1.09637988911

OK

## Sample Coordinates

```
Point,Northing,Easting,Elevation,Descript
90,15000.0000,11000.0000,0.0000,GRANT
91,15008.3755,10990.0184,0.0000,GRANT
92,15027.8573,10960.0192,0.0000,GRANT
93,15136.4522,10883.9802,0.0000,GRANT
94,15136.4522,10776.6602,0.0000,GRANT
95,15126.4853,10744.0597,0.0000,GRANT
96,15123.7945,10667.0067,0.0000,GRANT
97,15123.7945,10638.7067,0.0000,GRANT
98,15084.8497,10558.8578,0.0000,GRANT
99,15103.3462,10518.4399,0.0000,GRANT
```

# 5 Adjust Menu

- ▶ [Compass Rule](#) – Perform a compass rule adjustment on a **Closed Figure** or **Close to Known Point** traverse.
- ▶ [Rotate / Mirror](#) – **Rotate around Base Point**, **Rotate around Origin (0,0)** and **Mirror along Baseline**.
- ▶ [Shift / Average](#) – **Shift by  $\Delta X/\Delta Y/\Delta Z$** , **Shift by From/To Points** and **Average Points**.
- ▶ [Scale Points](#) – **Scale from Base Point**, and **Scale from Origin (0,0,0)**.
- ▶ [Transform Coordinates](#) – **Helmert Transformation** and **3D to Plan Cross Section**.

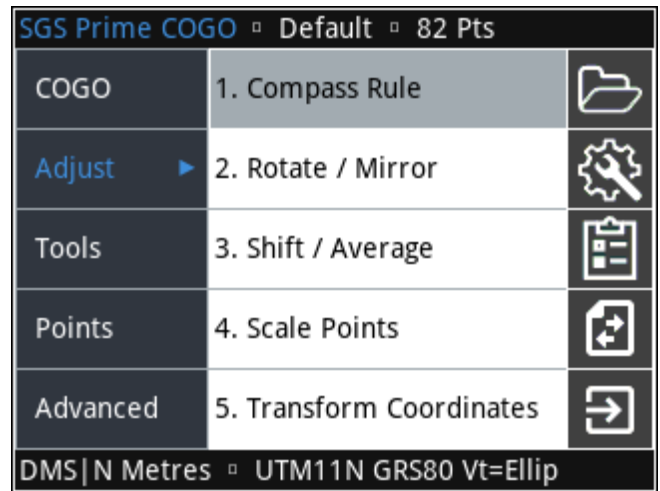

## 5.1 Compass Rule

A “compass rule” or “bowditch rule” adjustment distributes the linear misclose of a traverse proportionally throughout each leg of a traverse. A ‘closed figure’ traverse ends back on the starting point while a ‘close to fixed point’ traverse ends on a known control point that is held fixed.

### Closed Figure

A known starting point, followed by a series of intermediate points, and ending back on the starting point defines a closed figure. Prior to adjustment, the loop ending point coordinates as measured will differ from the starting point coordinates. The difference between these coordinates will be distributed proportionally through each leg of the figure.

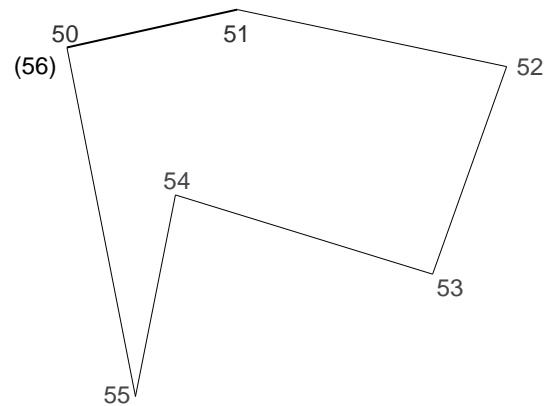

First, enter the point numbers using any of the [point numbers](#) input options, and select the Adjustment Type.

Next, an option to **Balance Angles** is presented. If the closing angle is known, choose “Yes”, otherwise choose “No”.

If the user selected “Yes” to balance angles, an input form will allow for the closing angle to be entered.

The COMPASS RULE RESULTS screen displays information about the adjustment including the angle balance information, precision, the perimeter of the figure, and the misclose information.

- Sol** Display the Adjustment Solution.
- Dist** Display the unadjusted and adjusted distances for each course of the traverse.
- Dir** Display the unadjusted and adjusted directions for each course of the traverse.
- Adjust** Proceed with adjusting the points.

Examples of the distance and direction result pages:

Compass Rule Adjustment		
Course	Unadjusted	Adjusted
50-51	67.904m	67.904m
51-52	94.813m	94.814m
52-53	77.425m	77.425m
53-54	95.442m	95.442m
54-55	60.877m	60.877m
55-56	111.857m	111.858m

Sol • Dist Dir Cancel Adjust

Compass Rule Adjustment		
Course	Unadjusted	Adjusted
50-51	74°57'54"	74°57'53"
51-52	104°55'33"	104°55'32"
52-53	200°11'48"	200°11'47"
53-54	290°02'17"	290°02'18"
54-55	187°55'44"	187°55'43"
55-56	343°09'38"	343°09'40"

Sol Dist • Dir Cancel Adjust

Proceeding with the adjustment will present the option to Renumber or Overwrite the existing point numbers. When renumbering, a description for the new points can also be set.

**Adjusted Points**

Adjust Points:

Additive #:

Description:  Original?

Add to existing Point ID(s)

Edit     Cancel Calc

### Sample Coordinates

```
Point,Northing,Eastng,Elevation,Descript
50,6102.894,4125.949,0.000,CRA_CLOSED
51,6120.510,4191.528,0.000,CRA_CLOSED
52,6096.092,4283.143,0.000,CRA_CLOSED
53,6023.426,4256.416,0.000,CRA_CLOSED
54,6056.123,4166.749,0.000,CRA_CLOSED
55,5995.827,4158.356,0.000,CRA_CLOSED
56,6102.885,4125.942,0.000,CRA_CLOSED
```

### Close to Fixed Point

A close to fixed point traverse begins on a known control point followed by a series of intermediate points and ends on a second known control point which will be held fixed. The difference between the measured ending point coordinates and the fixed values will be distributed proportionally through each leg of the traverse.

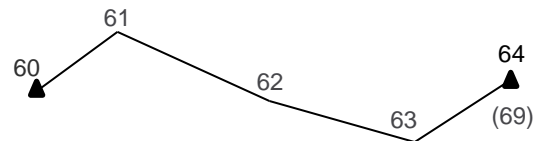

First, enter the point numbers using any of the [point numbers](#) input options, and select the Adjustment Type. When a 'Close to Fixed Point' type is selected, the following input form will ask for the Fixed Point.

The COMPASS RULE RESULTS screen displays information about the adjustment including the precision, the length of the figure, and the misclose information.

- Sol Display the Adjustment Solution.
- Dist Display the unadjusted and adjusted distances for each course of the traverse.
- Dir Display the unadjusted and adjusted directions for each course of the traverse.
- Adjust Proceed with adjusting the points.

### Sample Coordinates

```
Point,Northing,Easting,Elevation,Descript
60,7033.458,5311.207,0.000,CRA_KNOWN
61,7070.237,5360.793,0.000,CRA_KNOWN
62,7037.104,5460.587,0.000,CRA_KNOWN
63,7010.119,5550.529,0.000,CRA_KNOWN
64,7028.068,5612.263,0.000,CRA_KNOWN
69,7028.060,5612.266,0.000,CRA_KNOWN
```

## 5.2 Rotate/Mirror Points

**Rotate Points** around a base point or the coordinate system origin, and **Mirror Points** mirrors points along a baseline.

### Rotate around Base Point

First, enter the point number to use as a base point.

Next, select if you're entering a known rotation angle, or if you are calculating the rotation angle from two reference directions.

- ▶ Enter a positive angle for clockwise rotation and a negative angle for a counter clockwise rotation.
- ▶ Use any of the standard [directions](#) input options to enter reference directions.

Next, enter the points to rotate, and select how to store the newly calculated points.

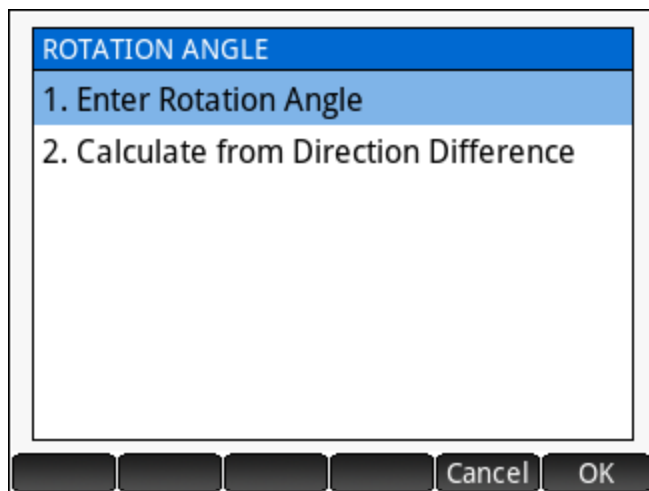

ROTATION ANGLE

1. Enter Rotation Angle
2. Calculate from Direction Difference

Cancel OK

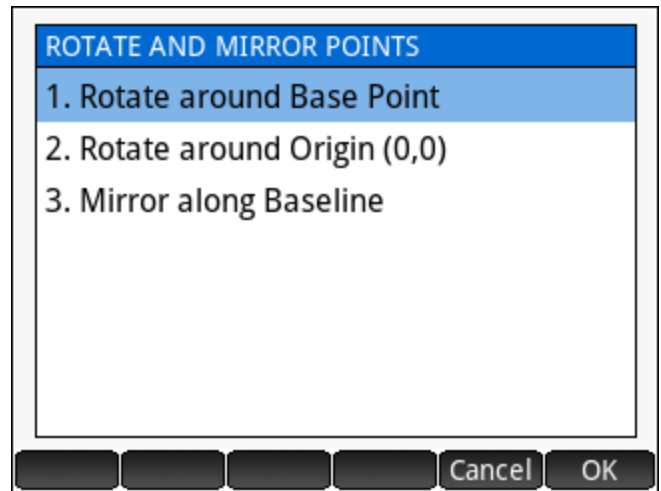

ROTATE AND MIRROR POINTS

1. Rotate around Base Point
2. Rotate around Origin (0,0)
3. Mirror along Baseline

Cancel OK

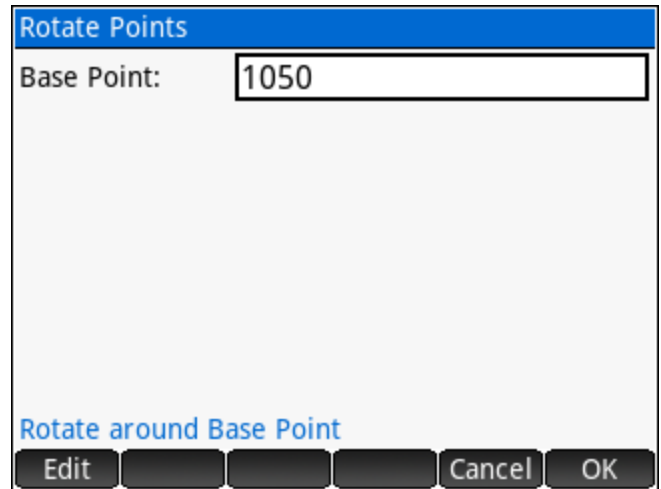

Rotate Points

Base Point: 1050

Rotate around Base Point

Edit Cancel OK

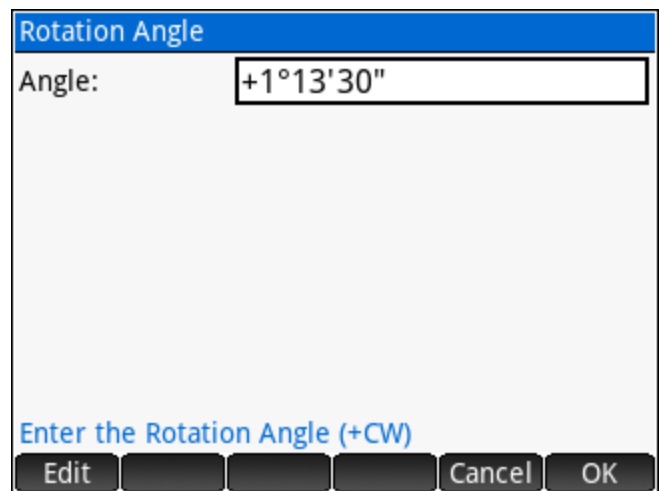

Rotation Angle

Angle: +1°13'30"

Enter the Rotation Angle (+CW)

Edit Cancel OK

## Rotate around Origin (0,0)

Like **Rotate Around Base Point**, except no base point is required, the points will be rotated around 0,0.

## Mirror along Baseline

First, enter two points to define a baseline.

Next, enter the points to mirror and specify how to store the new coordinates.

Mirror Points	
Baseline P1:	<input type="text" value="90"/>
Baseline P2:	<input type="text" value="99"/>
Baseline Point 1	
<input type="button" value="Edit"/>	<input type="button" value="Cancel"/> <input type="button" value="OK"/>

Mirror Points	
Point(s):	<input type="text" value="91..98"/>
All Points:	<input type="text"/>
Calc Points:	<input type="text" value="Overwrite"/>
Additive #:	<input type="text"/>
Description:	<input type="text" value="COGO"/> <input type="checkbox"/> Original? <input type="checkbox"/>
Overwrite or Renumber Calculated Points	
<input type="button" value="Choose"/>	<input type="button" value="Cancel"/> <input type="button" value="Calc"/>



## 5.3 Shift/Average Points

Point coordinates can be shifted by using one of three possible methods, and a range of point coordinates can be averaged to create a new point at the calculated average position. The 3D to Plan option transforms 3D measurements to 2D plan cross sections.

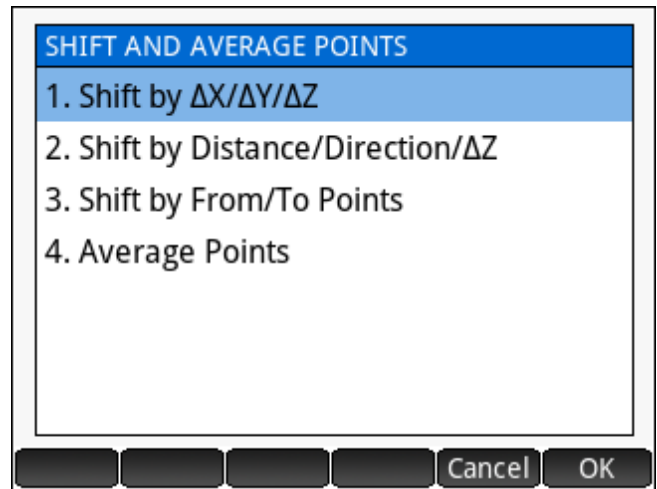

### Shift by $\Delta X/\Delta Y/\Delta Z$

Enter the changes in *Northing*, *Easting* and *Elevation* to define the shift parameters.

Next, enter the points to shift, and select how to store the newly calculated points.

A screenshot of a dialog box titled "Shift by  $\Delta X/\Delta Y/\Delta Z$ ". It has a blue header. Below the header, there are three input fields: "ΔNorth:" with "0.000m", "ΔEast:" with "0.000m", and "ΔElev:" with "0.000m". At the bottom left, there is a blue link "Northing Shift". At the bottom, there are buttons for "Edit", "Cancel", and "OK".

A screenshot of a dialog box titled "Shift Points". It has a blue header. Below the header, there are several input fields: "Point(s):" (empty), "All Points:" (checkbox), "Calc Points:" (dropdown menu showing "Overwrite"), "Additive #:" (empty), and "Description:" (text field with "COGO" and a checkbox for "Original?"). At the bottom, there is a blue link "Enter Point(s) to Shift (#..#, #, #..#)". At the bottom, there are buttons for "Edit", "Cancel", and "Calc".

## Shift by Distance/Direction/ $\Delta Z$

Enter the horizontal *Distance*, the *Bearing* and the change in *Elevation* to define the shift parameters.  
Use any of the standard [distances](#) and [directions](#) input options.

Next, enter the points to shift, and select how to store the newly calculated points.

The dialog box has a blue header with the text "Shift by Distance/Direction/ $\Delta Z$ ". It contains three input fields: "Distance:" with the value "0.000m", "Bearing:" with the value "0°00'00\"", and " $\Delta$ Elev:" with the value "0.000m". At the bottom, there is a blue link "Distance of Shift" and a row of buttons: "Edit", "Cancel", and "OK".

The dialog box has a blue header with the text "Shift Points". It contains several fields: "Point(s):" (empty), "All Points:" (checkbox), "Calc Points:" (dropdown menu showing "Overwrite"), "Additive #:" (empty), and "Description:" (text box with "COGO" and a checkbox labeled "Original?"). At the bottom, there is a blue link "Enter Point(s) to Shift (#..#,#,##..#)" and a row of buttons: "Edit", "Cancel", and "Calc".

## Shift by From/To Points

Enter the *From Point* and *To Point* to allow the program to calculate the 3D shift parameters between the two points.

Next, enter the points to shift, and select how to store the newly calculated points.

The dialog box has a blue header with the text "Shift by From/To Points". It contains two input fields: "From Point:" and "To Point:". At the bottom, there is a blue link "Shift From Point ..." and a row of buttons: "Edit", "Cancel", and "OK".

The dialog box has a blue header with the text "Shift Points". It contains several fields: "Point(s):" (empty), "All Points:" (checkbox), "Calc Points:" (dropdown menu showing "Overwrite"), "Additive #:" (empty), and "Description:" (text box with "COGO" and a checkbox labeled "Original?"). At the bottom, there is a blue link "Enter Point(s) to Shift (#..#,#,##..#)" and a row of buttons: "Edit", "Cancel", and "Calc".

## Average Points

Enter a series of points to compute their arithmetic mean coordinate values. Point numbers can be entered using any of the [point numbers](#) input options. At minimum two points are required to calculate average values.

The solution displays the calculated coordinates, their standard deviation and the range in coordinate values.

The user is given the option to store the averaged point in the project database.

Average Points

Point(s): 150..155

All Points:

Enter Point(s) to Average (#..#, #, #..#)

Edit Cancel Calc

Averaged 6 Points

Averaged Point

Northing: 2015.004m

Easting: 3509.997m

Elevation: 255.003m

Standard Deviation (Range)

Std Dev N: 0.006m (0.018m)

Std Dev E: 0.010m (0.028m)

Std Dev Z: 0.011m (0.030m)

Store OK

## 5.4 Scale Points

Scale Points from a Base Point or from the coordinate system origin (0,0).

### Scale from Base Point

Point coordinates can be scaled from a base point with separate scale factors for the horizontal and vertical components.

First, enter the point number to use as the **Base Point**.

Next, specify the horizontal and vertical scale factors.

Options exist on how to define the scale factors:

- ▶ **User Entered** – Enter a scale factor value. It is possible to enter a math operation such as  $1/0.99962051$  to calculate the scale factors.
- ▶ **Feet to Meters** – The scale factor is automatically determined.
- ▶ **Meters to Feet** – The scale factor is automatically determined.
- ▶ **Input Scale Factor** – From User Settings.
- ▶ **Output Scale Factor** – From User Settings.

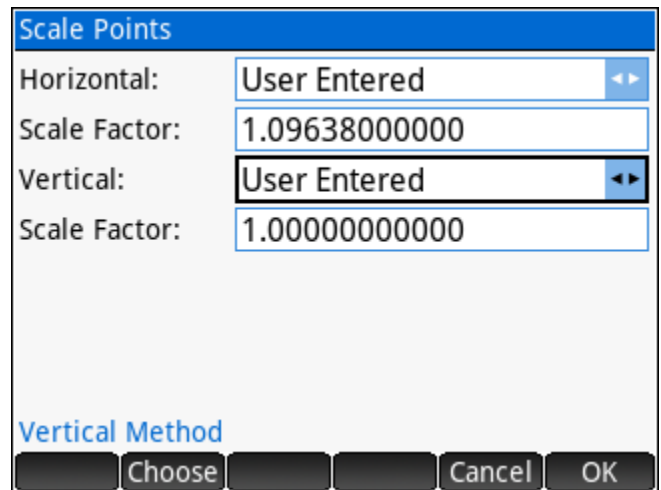
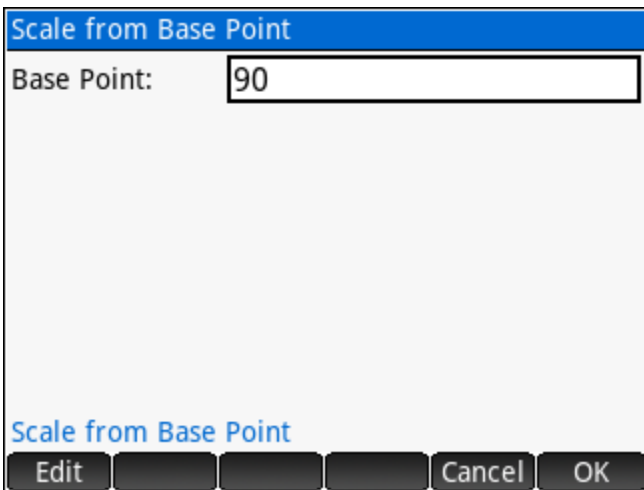
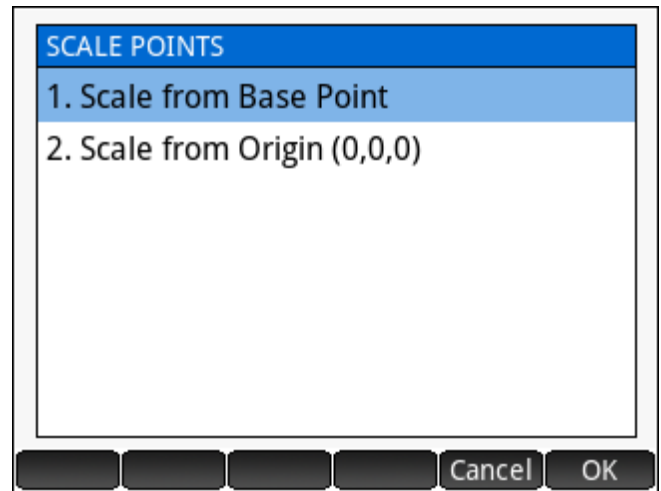

Last, enter the points to scale, and select how to store the newly calculated points.

### Scale from Origin (0,0,0)

Like **Scale from Base Point**, except no base point is required, the points will be scaled from 0,0,0.

## 5.5 Transform Coordinates

Transform point coordinates in one coordinate system to another by matching up control points using the **Helmert Transformation** tool or create 2D cross section points from points on a 3D feature such as a building face using the **3D to Plan Cross Section** utility.

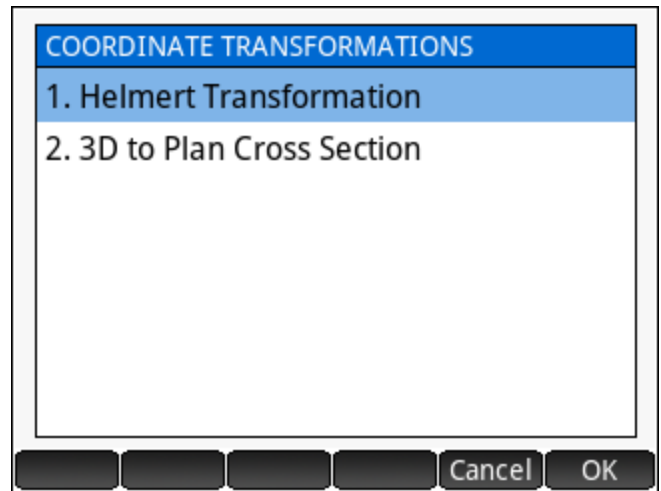

### Helmert Transformation

The **Helmert Transformation** program is a least squares coordinate transformation program that allows the user to transform points from one coordinate system to another. A two-dimensional conformal coordinate transformation (aka four-parameter similarity transformation) is used to calculate the least squares transformation. Scale, rotation and translation are computed when a minimum of two common control points are present in two separate coordinate systems. The procedure in general is:

1. Match up control points from both coordinate systems, i.e. these points represent the same objects in two different coordinate systems.
2. Calculate the transformation and review the residuals for each control pair that was defined.
3. If necessary, modify the control points used to address any “poorly fitting” control pairs.
4. Apply the transformation to a specified range of points.

The main **Helmert Transformation** screen accepts all input through the menu:

- Add** Add control pairs to be used for the calculation.
- Delete** Delete the selected control pair from the calculation.
- Edit** Edit the selected control pair.
- Param** Set the Scale **Parameter**, which can be fixed at 1 or calculated best fit. The title in the header indicates (No Scale) when the scale parameter is fixed, or (Scaled) when the calculated scale factor will be applied.

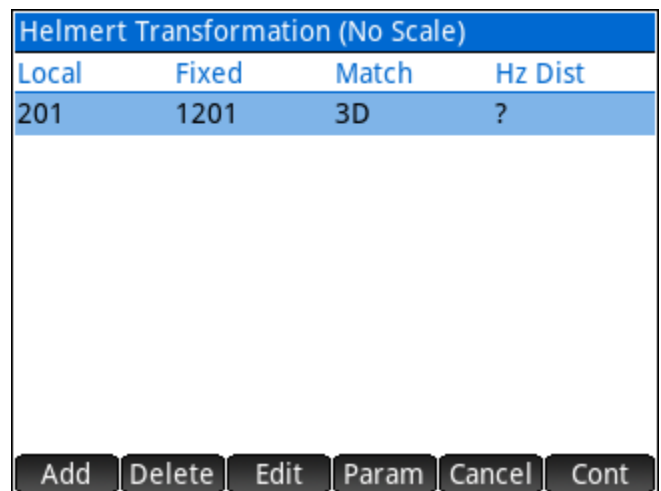

Once at least two pairs are added, their horizontal distance residuals are displayed.

### Add Control Pairs

The **Local Point** is in the coordinate system that you wish to transform, while the **Fixed Point** is in the coordinate system that is not changing. Points can be matched in 1D, 2D, 3D or None. You may continue entering all your control pairs without leaving the DEFINE CONTROL PAIRS input form.

### Delete or Edit Control Pairs

Control pairs can be deleted or edited when necessary. From the main **Helmert Transformation** screen, select a control pair and use menu options to delete or edit the selected control points. The screen updates immediately to reflect the changes made.

Local	Fixed	Match	Hz Dist
201	1201	3D	0.001m
202	1202	3D	0.001m
203	1203	3D	0.002m

### Calculate Solution

Use **Cont** to display the calculated transformation parameters based on the defined control pairs.

The solution presented displays the best-fit transformation parameters (scale, rotation, and translation in northing and easting) as well as the standard deviation in the northing and easting and the calculated average elevation shift between any/all control pairs that were matched 3D. The menu:

- Sol** Display the transformation solution.
- ΔXYZ** Display the coordinate residuals for each control pair.
- ΔPol** Display the polar distance and direction residuals for each control pair.
- Back** Return to the previous input screen to Add/Delete/Edit control pairs.

Examples of the residual screens:

Helmert Transformation (No Scale)				
Local	Fixed	$\Delta N$	$\Delta E$	$\Delta Z$
201	1201	0.001m	-0.001m	0.000m
202	1202	0.000m	-0.001m	0.000m
203	1203	-0.001m	0.002m	0.001m

Sol   $\Delta XYZ$    $\Delta Pol$  Back Cont

Helmert Transformation (No Scale)			
Local	Fixed	Hz Dist	Azimuth
201	1201	0.001m	323°29'55"
202	1202	0.001m	242°12'28"
203	1203	0.002m	116°04'34"

Sol   $\Delta XYZ$    $\Delta Pol$  Back Cont

### Apply Transformation

Use **Cont** when ready to apply the transformation.

Enter the points to transform and select how to store the newly calculated points.

Transform Points	
Point(s):	<input type="text" value="201..207"/>
All Points:	<input type="checkbox"/>
Calc Points:	<input type="text" value="Renumber"/>
Additive #:	<input type="text" value="100"/>
Description:	<input type="text" value="COGO"/> Original? <input checked="" type="checkbox"/>
Copy Original Description?	
<input type="checkbox"/> <input checked="" type="checkbox"/> <input type="checkbox"/> <input type="checkbox"/> Cancel Calc	

### Sample Coordinates

```

Point,Northing,Easting,Elevation,Description
201,5366358.241,470146.326,22.112,HT_LOCAL
202,5366207.625,470340.584,17.416,HT_LOCAL
203,5366043.182,470551.834,14.643,HT_LOCAL
204,5366215.676,470348.232,0.000,HT_LOCAL
205,5366290.117,470401.822,0.000,HT_LOCAL
206,5366123.497,470616.424,0.000,HT_LOCAL
207,5366048.800,470552.152,0.000,HT_LOCAL
1201,5366557.381,470050.977,22.107,HT_FIXED
1202,5366406.762,470245.234,17.411,HT_FIXED
1203,5366242.317,470456.485,14.639,HT_FIXED
    
```

### 3D to Plan Cross Section

In the diagram on the right, consider the red dots shown as being reflector-less measurements made with a total station. The goal is to calculate the ratio of glass surface area to total surface area of the wall. The 3D to Plan program transforms the 3D measured coordinates into 2D plan points to create a section view.

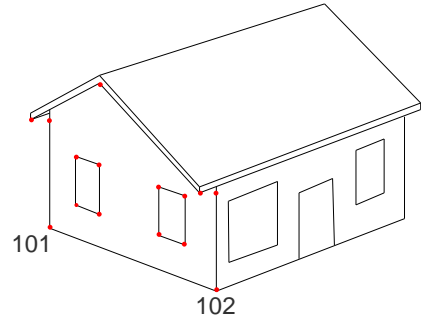

First, define the section cut line by entering a point towards the left of the section cut line, and a point to the right of the section cut line. Consider the points measured at the base of the walls as the section cut line, Point 101 on the left and Point 102 on the right. Elevations of the calculated points can be calculated from their offsets relative to the baseline, or the elevations can be set to zero, if not important.

Next, enter the points to transform, and select how to store the newly calculated points.

Define Cross Section	
Point Left:	101
Point Right:	102
Elevations:	Cross Section Offset
<p>Calculate Elevations or set to Zero?</p>	
<p>Choose Cancel OK</p>	

Transform Points	
Point(s):	101..115
All Points:	<input type="checkbox"/>
Calc Points:	Renumber
Additive #:	1000
Description:	COGO <input type="checkbox"/> Original? <input checked="" type="checkbox"/>
<p>Add to existing Point ID(s)</p>	
<p>Edit Cancel Calc</p>	

### Sample Coordinates

```

101,5000.000,5000.000,68.743,3D2PLAN
102,4982.603,5019.322,68.743,3D2PLAN
103,5000.000,5000.000,77.743,3D2PLAN
104,4982.603,5019.322,76.743,3D2PLAN
105,4997.323,5002.973,71.743,3D2PLAN
106,4994.647,5005.945,71.743,3D2PLAN
107,4997.323,5002.973,75.743,3D2PLAN
108,4994.647,5005.945,75.743,3D2PLAN
109,4987.956,5013.377,71.743,3D2PLAN
110,4985.279,5016.349,71.743,3D2PLAN
111,4987.956,5013.377,75.743,3D2PLAN
112,4985.279,5016.349,75.743,3D2PLAN
113,4999.852,4997.175,78.243,3D2PLAN
114,4979.778,5019.470,78.243,3D2PLAN
115,4989.815,5008.323,84.493,3D2PLAN
    
```



# 6 Tools Menu

- ▶ [Triangle Solver](#) – Solve a plane triangle from three known values.
- ▶ [Horizontal Curves](#) –Features a **Circular Curve Solver**, **Curve Through Fixed Point Solver**, and a **Spiral Curve Solver**.
- ▶ [Vertical Curves](#) – Various methods including **Grades and Length known**, **Elevations and Length known**, **Fixed Point**, **VPI and Grades known**, **Fixed Point**, **BVC and Grades known** and **Intersect Slopes from two known points**.
- ▶ [RPN Calculator](#) – Calculator app designed for survey calculations.
- ▶ [Configure Settings](#) – Configure User Settings.

SGS Prime COGO ▫ Default ▫ 82 Pts		
COGO	1. Triangle Solver	
Adjust	2. Horizontal Curves	
Tools	▶ 3. Vertical Curves	
Points	4. RPN Calculator	
Advanced	5. Configure Settings	
DMS   N Metres ▫ UTM11N GRS80 Vt=Ellip		

## 6.1 Triangle Solver

The triangle solver accepts three known values (at least one of which must be a side) and solves for the remaining values.

For side value inputs, any of the standard [distances](#) input options are accepted to allow the user to inverse points in the current job database to calculate distances for triangle sides, as well as any of the other operations.

The output screen displays the solved values, including the triangle area and perimeter.

### Plane Triangle Solver

A:	<input type="text"/>	
c:	<input type="text" value="3.000m"/>	
B:	<input type="text"/>	
a:	<input type="text" value="4.000m"/>	
C:	<input type="text"/>	
b:	<input type="text" value="5.000m"/>	

Angle A

Edit
Cancel
Solve

### Plane Triangle Solution

Angle A:	53°07'48"	
Side c:	3.000m	
Angle B:	90°00'00"	
Side a:	4.000m	
Angle C:	36°52'12"	
Side b:	5.000m	
Area:	6.000m <sup>2</sup>	
Perimeter:	12.000m	

COPY
STOV
OK

## 6.2 Horizontal Curves

Three options to solve horizontal curves:

1. [Circular Curve Solver](#) – Solve a simple circular curve by entering two known elements.
2. [Curve Through Fixed Point](#) – Calculate the curve that passes through a fixed point. Calculations are possible when a point on the back tangent, at the PI, on the forward tangent, and the fixed point are provided.
3. [Spiral Curve Solver](#) – Solves all the Spiral-Curve-Spiral parameters when entering a Spiral Length, a total SCS deflection angle, and the curve radius.

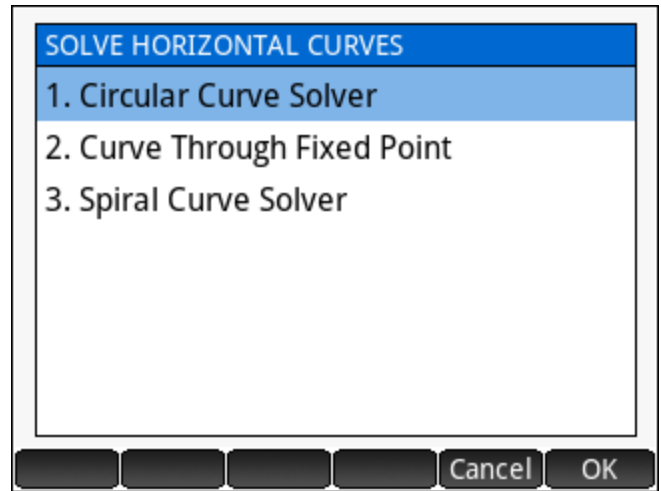

### Circular Curve Solver

The circular curve solver requires two known curve elements and solves for the rest. Acceptable input combinations include:

- ▶ The radius and any of the other accepted inputs.
- ▶ The deflection angle and any of the other accepted inputs.
- ▶ The arc length and the chord length. **NOTE: THIS TYPE OF SOLUTION INVOKES THE ITERATIVE NEWTON'S METHOD TO SOLVE FOR THE REMAINING VALUES. THE RESULT ACCURACY DEPENDS ON THE INPUT PRECISION.**

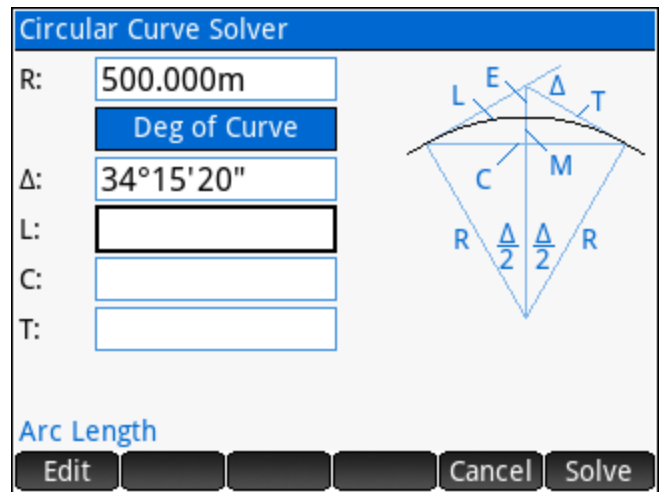

### Degree of Curve

A **Deg of Curve** button provides easy access to determine the radius of the curve by degree of curve, both chord and arc definitions are available.

The solution displays all the elements of the circular curve, including the sector, segment and fillet areas.

The **Calc** button on the menu features Tangent Offset calculations.

Circular Curve Solution	
Radius:	500.000m
Defl Angle:	34°15'20"
Arc:	298.936m
Chord:	294.504m
Tangent:	154.085m
Mid-Ord:	22.175m
External:	23.204m
Sector Area:	74734.029m <sup>2</sup>
Segment Area:	4373.395m <sup>2</sup>
Fillet Area:	2308.708m <sup>2</sup>

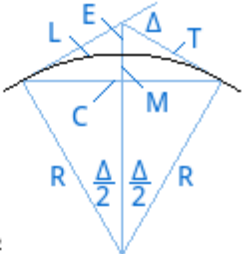

Calc COPY STOV OK

### Curve Calculations

Further calculations are possible with the solved curve parameters.

- ▶ **Tangent Offset by Station** – Enter any station on the curve to calculate the tangent distance and offset to layout the curve using the Tangent Offset method.
- ▶ **Tangent Offsets by Interval** – Calculates the tangent distances and offsets for all stations on the curve at a specified interval.
- ▶ **Sub-Chord by Station** – Enter any station on the curve to calculate the turned angle and chord distance from either end of curve to layout the curve using the Sub-Chord method.
- ▶ **Sub-Chords by Interval** – Calculates the turned angles and chord distances for all stations on the curve at the specified interval.

For all methods, enter the known station at either the BC, PI or EC to continue with the calculations.

CURVE CALCULATIONS
1. Tangent Offset by Station
2. Tangent Offsets by Interval
3. Sub-Chord by Station
4. Sub-Chords by Interval

Cancel OK

Tangent Offset by Station	
Known Station:	BC
Station:	0+000.000

Choose Known Station

Choose Cancel OK

### Tangent Offset by Station

Enter any station on the curve, enter an offset from centerline (optional), choose the curve direction, and choose the Calculation Reference (Shortest tangent distance, From BC, or From EC) to calculate and display the tangent distance and tangent offset.

**Tangent Offset by Station**

Station:

Offset:

Direction:  <>

Reference:  <>

Radial Offset (+Right, -Left)

Edit

**Tangent Offset by Station**

Station:

Offset:

Direction:  <>

Reference:  <>

Distance: (From BC)  
34.971m  
Offset:  
+1.224m

Radial Offset (+Right, -Left)

### Tangent Offset by Intervals

Enter the station interval, enter an offset from centerline (optional), choose the curve direction, and choose the Calculation Reference (Shortest tangent distance, From BC, or From EC) to calculate and display the tangent distances and tangent offsets for all stations at the given interval.

**Tangent Offsets by Interval**

Interval:

Offset:

Direction:  <>

Reference:  <>

Radial Offset (+Right, -Left)

Edit

**Tangent Offsets by Interval**

Station	Reference	Distance	Offset
0+000.000	From BC	0.000m	+0.000m
0+020.000	From BC	19.995m	+0.400m
0+040.000	From BC	39.957m	+1.599m
0+060.000	From BC	59.856m	+3.596m
0+080.000	From BC	79.659m	+6.386m
0+100.000	From BC	99.335m	+9.967m
0+120.000	From BC	118.851m	+14.331m
0+140.000	From BC	138.178m	+19.472m
0+160.000	From EC	137.155m	-19.179m

### Sub-Chord by Station

Enter any station on the curve, enter an offset from centerline (optional), choose the curve direction, and choose the Calculation Reference (Shortest chord distance, From BC, or From EC) to calculate and display the chord distance and turned angle.

**Sub-Chord by Station**

Station:

Offset:

Direction:  <>

Reference:  <>

Enter Station to Solve

Edit

**Sub-Chord by Station**

Station:

Offset:

Direction:  <>

Reference:  <>

Chord: (From BC)  
34.993m  
Angle:  
+2°00'19"

Radial Offset (+Right, -Left)

### Sub-Chords by Intervals

Enter the station interval, enter an offset from centerline (optional), choose the curve direction, and choose the Calculation Reference (Shortest chord distance, From BC, or From EC) to calculate and display the chord distances and turned angles for all stations at the given interval.

**Sub-Chords by Interval**

Interval:

Offset:

Direction:  <>

Reference:  <>

Radial Offset (+Right, -Left)

Edit

**Sub-Chords by Interval**

Station	Reference	Chord	Angle
0+000.000	From BC	0.000m	+0°00'00"
0+020.000	From BC	19.999m	+1°08'45"
0+040.000	From BC	39.989m	+2°17'31"
0+060.000	From BC	59.964m	+3°26'16"
0+080.000	From BC	79.915m	+4°35'01"
0+100.000	From BC	99.833m	+5°43'46"
0+120.000	From BC	119.712m	+6°52'32"
0+140.000	From BC	139.543m	+8°01'17"
0+160.000	From EC	138.490m	-7°57'38"

## Curve Through Fixed Point

The Curve through Fixed Point solver solves a curve that is required to fit fixed tangents and a fixed point. In the diagram to the right, let's assume that the back tangent from Point 1 to Point 2 is a street curb line, and the forward tangent from Point 2 to Point 3 is also a street curb line. A curve is required so that the curb will pass through Point 4, which represents the back of a catch basin, for example.

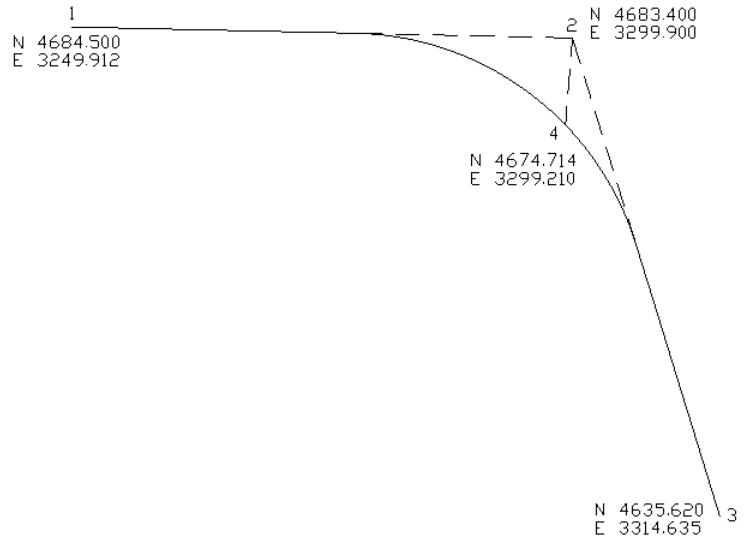

In the input form; enter the points on the BT (Back Tangent), at the PI (Point of Intersection), on the FT (Forward Tangent), and OC (On the Curve).

The diagram is for general reference only.

### Sample Coordinates

Point	Northing	Easting
1	4684.500	3249.912
2	4683.400	3299.900
3	4635.620	3314.635
4	4674.714	3299.210

Curve Through Fixed Point

BT Point:

PI Point:

FT Point:

OC Point:

Enter Point on Back Tangent

Edit Cancel OK

The solution displays the curve parameters, and the updated diagram shows the direction of the solved curve by placing the BC & EC labels at the appropriate locations.

After reviewing the solution, the options to store the calculated Radius Point, the calculated BC Point, and the calculated EC Point will be presented.

**Circular Curve Solution**

Radius:	29.959m
Defl Angle:	71°36'00"
Arc:	37.438m
Chord:	35.049m
Tangent:	21.607m
Mid-Ord:	5.660m
External:	6.979m
Sector Area:	560.791m <sup>2</sup>
Segment Area:	134.977m <sup>2</sup>
Fillet Area:	86.516m <sup>2</sup>

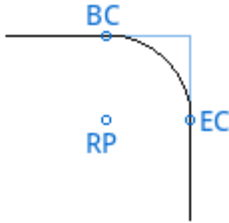

COPY
STOV
OK

### Spiral Curve Solver

Solve all parameters of an equal spiral transition curve. Input the **Spiral Length**, **Total Deflection Angle**, and **Curve Radius** to solve the rest. The Curve Radius can also be solved by using the **Deg of Curve** button.

The solution is displayed on two pages, toggle the page by using the menu.

See the next page for a diagram of the spiral geometry.

**Spiral Curve Solver**

Spiral Length:	<input type="text" value="50.000m"/>
Δ Total SCS:	<input type="text" value="28°38'52"/>
Curve Radius:	<input type="text" value="300.000m"/>
<span style="background-color: #0070C0; color: white; padding: 2px 10px; border: 1px solid black;">Deg of Curve</span>	

**Length of spiral portion**

Edit
Cancel
Solve

**Spiral Curve Solution**

SCS Total Δ:	28°38'52"
SCS Tangent:	101.685m
Parameter A:	122.474487139
Curve Radius:	300.000m
Curve Δ:	19°05'55"
Curve Length:	99.999m
Curve Chord:	99.537m
Curve Tangent:	50.468m

• SCS1
SCS2
COPY
STOV
OK

**Spiral Curve Solution**

Spiral Δ:	4°46'29"
Spiral Length:	50.000m
Long Chord:	49.985m
Short Tangent:	16.678m
Long Tangent:	33.345m
Parameter X:	49.965m
Parameter Y:	1.388m
Parameter q:	24.994m
Parameter p:	0.347m

SCS1
• SCS2
COPY
STOV
OK

## Reference Diagram

The diagram below illustrates the spiral geometry and associated symbols.

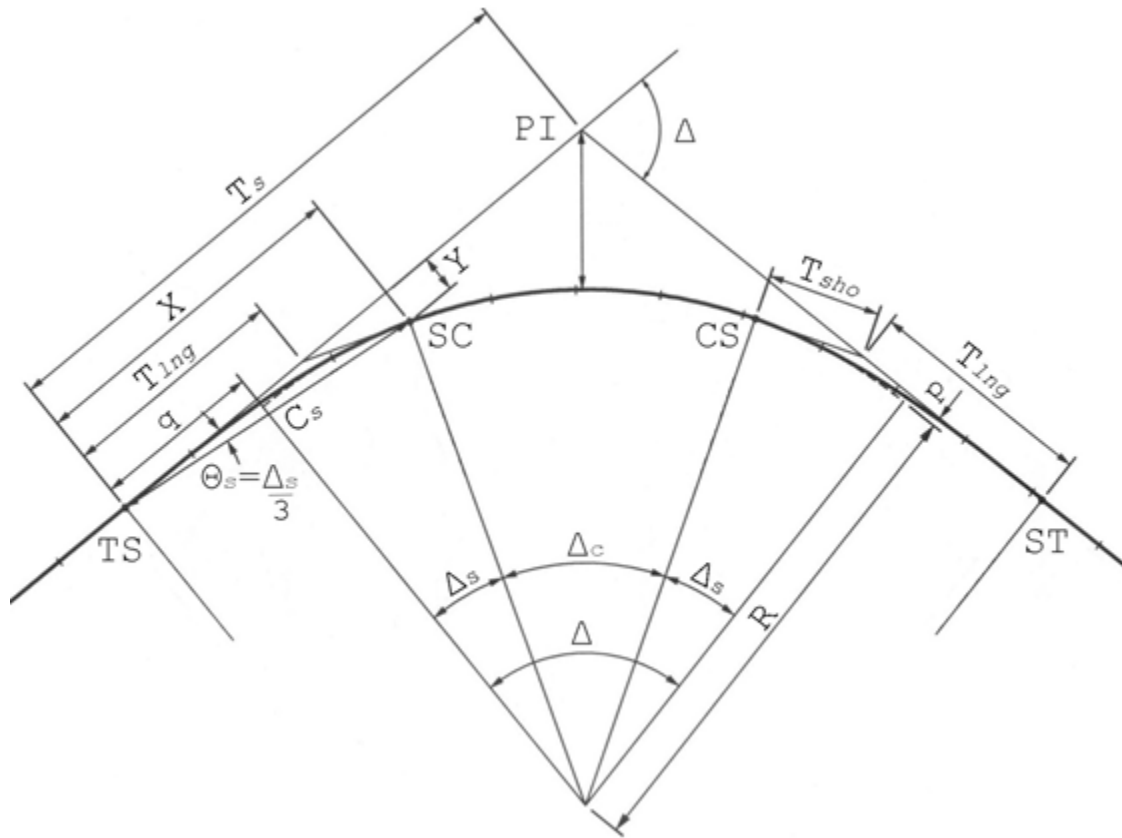

Below is a table legend of the spiral parameter symbols.

Ts	Tangent of Spiral-Curve-Spiral	Cs	Long Chord (Spiral)
X	Distance along Tangent from TS to Point at Right Angle to SC	Cc	Curve Chord (not labelled)
Y	Right Angle distance from Tangent to SC	$\Delta_s$	Spiral Delta
Tlng	Long Tangent (Spiral)	$\Delta_c$	Curve Delta
Tsho	Short Tangent (Spiral)	$\Delta$	Total Delta
Ls	Length of Spiral (not labelled)	A	Spiral Parameter
q	Distance along Tangent to a Point at Right Angle to Ghost BC	R	Curve Radius
p	Distance from Tangent that the Curve (Ghost BC) has been Offset	Lc	Length of Curve (not labelled)
Tc	Tangent of Curve (not labelled)		



## 6.3 Vertical Curves

The Vertical Curve Solver solves vertical curves using various combinations of known parameters, including:

1. **Grades and Length known** – Requires a known station at the BVC, VPI or EVC, the vertical curve length, entry and exit grades, and a known elevation at the BVC VPI, EVC or the High/Low point on the curve.
2. **Elevations and Length known** – Requires a known station at the BVC, VPI or EVC, the vertical curve length, and elevations at the BVC, VPI and EVC.
3. **Fixed Point, VPI and Grades known** – Requires the station and elevation at the VPI, a fixed-point station and elevation, entry and exit grades.
4. **Fixed Point, BVC and Grades known** – Requires the station and elevation at the BVC, a fixed-point station and elevation, entry and exit grades.
5. **Intersect Slopes from two known points** – Requires the vertical curve length, the entry grade, a station with a known elevation on the entry tangent, the exit grade, and a station with a known elevation on the exit tangent.

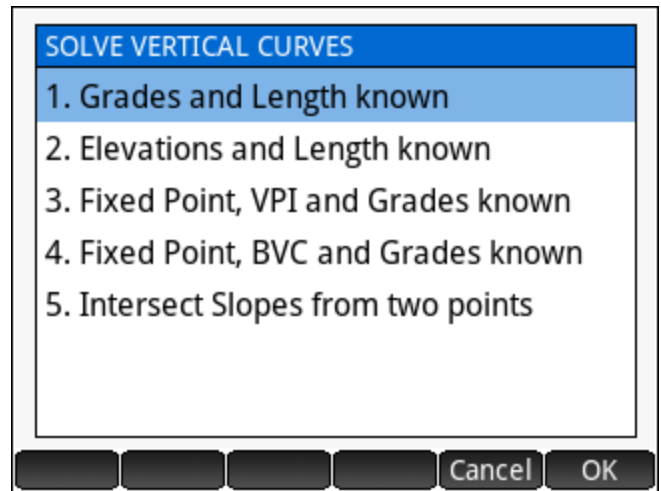

NOTE: **BVC** = Beginning of Vertical Curve, **VPI** = Vertical Point of Intersection, and **EVC** = End of Vertical Curve.

The diagram below illustrates the vertical curve geometry.

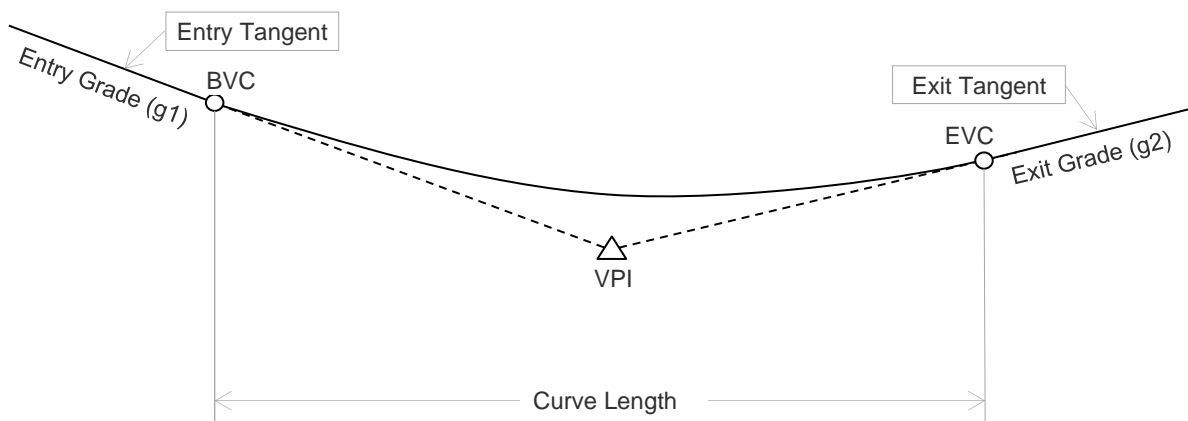

## Grades and Length known

Enter all the required information to solve the curve.

- ▶ Choose the point on the vertical curve with a known station (BVC, VPI or EVC)
- ▶ Enter the known station for the point
- ▶ Choose the point on the vertical curve with a known elevation (BVC, VPI, EVC or the High/Low Point)
- ▶ Enter the known elevation for the point
- ▶ Enter the vertical curve length
- ▶ Enter the entry grade
- ▶ Enter the exit grade

Vertical Curve Solver	
Known Station:	BVC
Station:	0+000.000
Known Elevation:	VPI
Elevation:	235.500m
Curve Length:	100.000m
Entry Grade:	-8.1 %
Exit Grade:	6.5 %
Choose Known Station	
Choose Cancel Solve	

The solution displays the stations and elevations for each the BVC, VPI, EVC and High/Low Point. See the [Solution Screen and Calculations](#) section for more information.

Vertical Curve Solution	
BVC Station:	0+000.000
BVC Elev:	239.550m
VPI Station:	0+050.000
VPI Elev:	235.500m
EVC Station:	0+100.000
EVC Elev:	238.750m
Low Station:	0+055.479
Low Elevation:	237.303m
Curve Length:	100.000m
Entry Grade:	-8.1 %
Exit Grade:	6.5 %
• Sol Int Elev? Sta? OK	

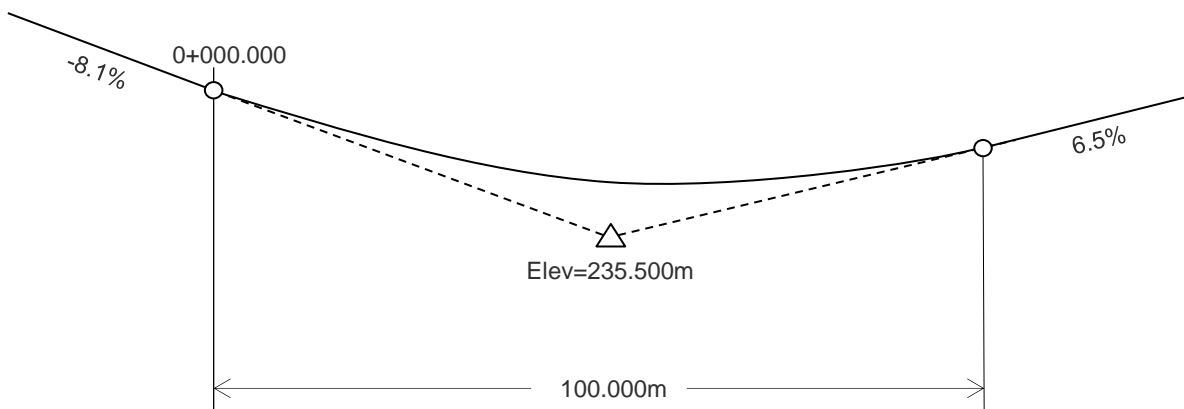

## Elevations and Length known

Enter all the required information to solve the curve.

- ▶ Choose the point on the vertical curve with a known station (BVC, VPI or EVC)
- ▶ Enter the known station for the point
- ▶ Enter the vertical curve length
- ▶ Enter the BVC elevation
- ▶ Enter the VPI elevation
- ▶ Enter the EVC elevation

Vertical Curve Solver	
Known Station:	BVC
Station:	0+000.000
Curve Length:	100.000m
BVC Elevation:	239.550m
VPI Elevation:	235.500m
EVC Elevation:	238.750m

Choose Known Station

Choose Cancel Solve

The solution displays the stations and elevations for each the BVC, VPI, EVC and High/Low Point. See the [Solution Screen and Calculations](#) section for more information.

Vertical Curve Solution	
BVC Station:	0+000.000
BVC Elev:	239.550m
VPI Station:	0+050.000
VPI Elev:	235.500m
EVC Station:	0+100.000
EVC Elev:	238.750m
Low Station:	0+055.479
Low Elevation:	237.303m
Curve Length:	100.000m
Entry Grade:	-8.1 %
Exit Grade:	6.5 %

• Sol Int Elev? Sta? OK

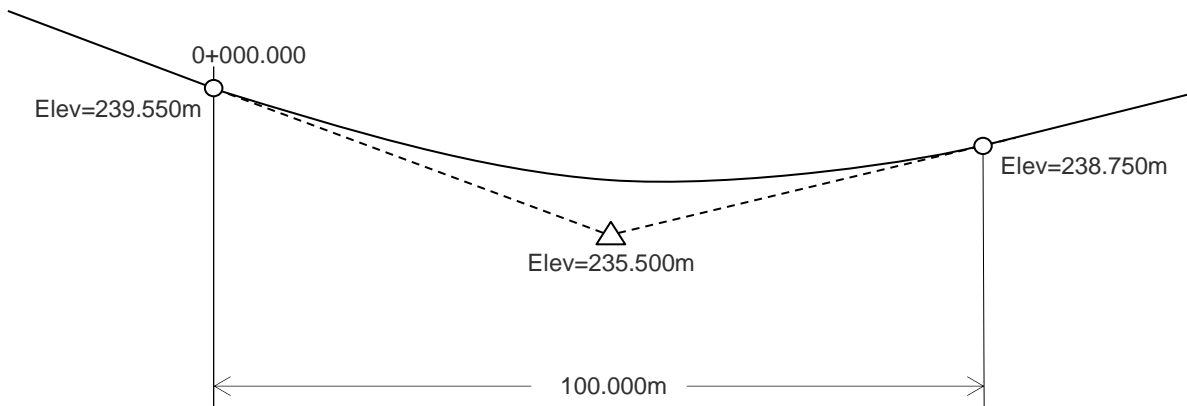

## Fixed Point, VPI and Grades known

Enter all the required information to solve the curve.

- ▶ Enter the VPI station
- ▶ Enter the VPI elevation
- ▶ Enter the fixed station
- ▶ Enter the elevation at the fixed station
- ▶ Enter the entry grade
- ▶ Enter the exit grade

Vertical Curve Solver	
VPI Station:	0+050.000
VPI Elevation:	235.500m
Fixed Station:	0+020.000
Fixed Elevation:	238.222m
Entry Grade:	-8.1 %
Exit Grade:	6.5 %

Enter VPI Station

Edit [ ] [ ] [ ] [ ] Cancel Solve

The solution displays the stations and elevations for each the BVC, VPI, EVC and High/Low Point. See the [Solution Screen and Calculations](#) section for more information.

Vertical Curve Solution	
BVC Station:	0+000.000
BVC Elev:	239.550m
VPI Station:	0+050.000
VPI Elev:	235.500m
EVC Station:	0+100.000
EVC Elev:	238.750m
Low Station:	0+055.479
Low Elevation:	237.303m
Curve Length:	100.000m
Entry Grade:	-8.1 %
Exit Grade:	6.5 %

• Sol Int Elev? Sta? OK

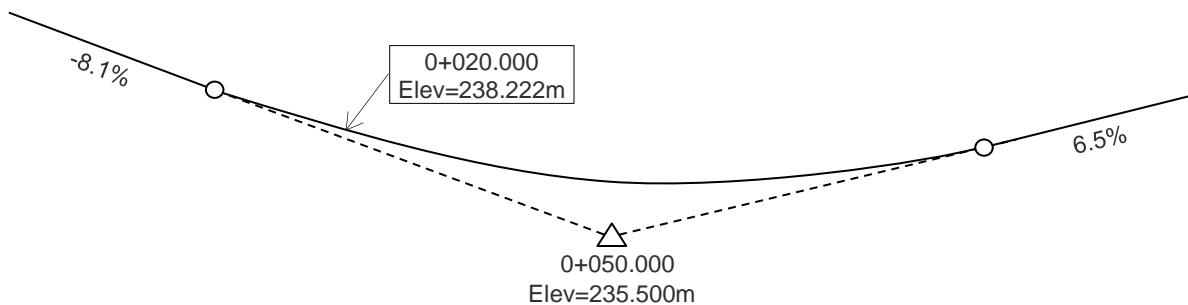

## Fixed Point, BVC and Grades known

Enter all the required information to solve the curve.

- ▶ Enter the BVC station
- ▶ Enter the BVC elevation
- ▶ Enter the fixed station
- ▶ Enter the elevation at the fixed station
- ▶ Enter the entry grade
- ▶ Enter the exit grade

Vertical Curve Solver		
BVC Station:	0+000.000	
BVC Elevation:	239.550m	
Fixed Station:	0+020.000	
Fixed Elevation:	238.222m	
Entry Grade:	-8.1 %	
Exit Grade:	6.5 %	
Enter VPI Station		
Edit	Cancel	Solve

The solution displays the stations and elevations for each the BVC, VPI, EVC and High/Low Point. See the [Solution Screen and Calculations](#) section for more information.

Vertical Curve Solution				
BVC Station:	0+000.000			
BVC Elev:	239.550m			
VPI Station:	0+050.000			
VPI Elev:	235.500m			
EVC Station:	0+100.000			
EVC Elev:	238.750m			
Low Station:	0+055.479			
Low Elevation:	237.303m			
Curve Length:	100.000m			
Entry Grade:	-8.1 %			
Exit Grade:	6.5 %			
• Sol	Int	Elev?	Sta?	OK

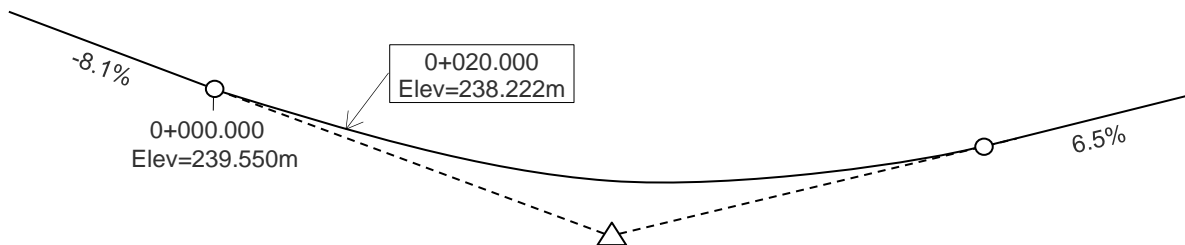

## Intersect Slopes from two known points

Enter all the required information to solve the curve.

- ▶ Enter the curve length
- ▶ Enter the entry grade
- ▶ Enter a known station on the entry tangent
- ▶ Enter the elevation at the known station
- ▶ Enter the exit grade
- ▶ Enter a known station on the exit tangent
- ▶ Enter the elevation at the known station

Vertical Curve Solver	
Curve Length:	100.000m
Entry Grade:	-8.1 %
Entry Station:	0+010.000
Entry Elevation:	238.740m
Exit Grade:	6.5 %
Exit Station:	0+106.000
Exit Elevation:	239.140m
Vertical Curve Length	
Edit	Cancel Solve

The solution displays the stations and elevations for each the BVC, VPI, EVC and High/Low Point. See the [Solution Screen and Calculations](#) section for more information.

Vertical Curve Solution	
BVC Station:	0+000.000
BVC Elev:	239.550m
VPI Station:	0+050.000
VPI Elev:	235.500m
EVC Station:	0+100.000
EVC Elev:	238.750m
Low Station:	0+055.479
Low Elevation:	237.303m
Curve Length:	100.000m
Entry Grade:	-8.1 %
Exit Grade:	6.5 %
• Sol	Int Elev? Sta? OK

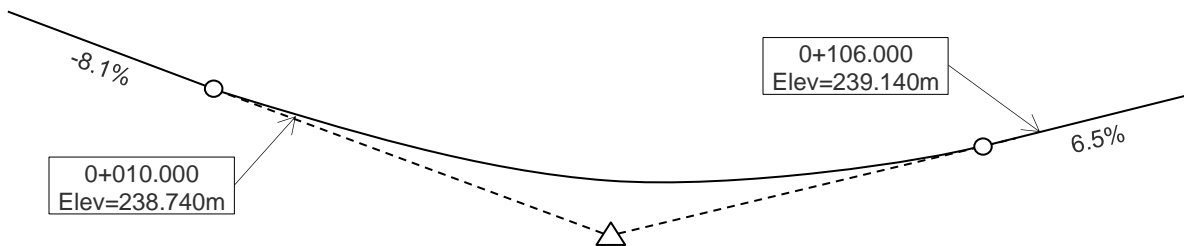

## Solution Screen and Calculations

For each of the combinations of known parameters to solve a vertical curve; the solution screen displays the unknown solved parameters, and the menu on the solution screen is the same for all combinations, offering the same functionalities:

**Int** Calculate elevations at all stations at a given [interval](#).

**Elev?** [Calculate elevations](#) on the vertical curve by entering a station.

**Sta?** [Calculate stations](#) on the vertical curve by entering an elevation.

Vertical Curve Solution	
BVC Station:	0+000.000
BVC Elev:	239.550m
VPI Station:	0+050.000
VPI Elev:	235.500m
EVC Station:	0+100.000
EVC Elev:	238.750m
Low Station:	0+055.479
Low Elevation:	237.303m
Curve Length:	100.000m
Entry Grade:	-8.1 %
Exit Grade:	6.5 %

• Sol Int Elev? Sta? OK

## Calculate Intervals

Enter a station interval to solve the elevations and instantaneous grade for each station at the given interval. The BVC and EVC elevations are always solved, regardless of their station. Scroll down to see all the results if they do not fit on one screen.

Solve Intervals	
Interval:	10.000m
Station Interval to Solve	
Edit	Solve

Vertical Curve Solution		
Station	Elevation	Instant
0+000.000 BVC	239.550m	-8.1 %
0+010.000	238.813m	-6.6 %
0+020.000	238.222m	-5.2 %
0+030.000	237.777m	-3.7 %
0+040.000	237.478m	-2.3 %
0+050.000	237.325m	-0.8 %
0+060.000	237.318m	0.7 %
0+070.000	237.457m	2.1 %
0+080.000	237.742m	3.6 %

Sol • Int Elev? Sta? OK

## Calculate Elevations

Enter any station to solve its elevation on the vertical curve.

When entering a station lower than the BVC station or greater than the EVC station, a notation will indicate such a case.

Solve Elevation

Station: 0+020.000

Enter Station to Solve

Edit Cancel Solve

Solve Elevation

Station: 0+020.000

Elevation at 0+020.000:  
238.222m  
Instantaneous Grade:  
-5.2 %

Enter Station to Solve

OK

## Calculate Stations

Enter an elevation to solve the station(s) on the vertical curve. Both solutions are displayed when two solutions exist. Only stations between the BVC and EVC are solved.

Solve Station(s)

Elevation: 238.222m

Enter Elevation to Solve

Edit Cancel Solve

Solve Station(s)

Elevation: 238.222m

Station(s) at 238.222m:  
0+020.000  
0+090.959

Enter Elevation to Solve

OK



## 6.4 RPN Calculator

The RPN Calculator is designed for survey calculations with units for distance, angle, area and volume.

### Main Interface

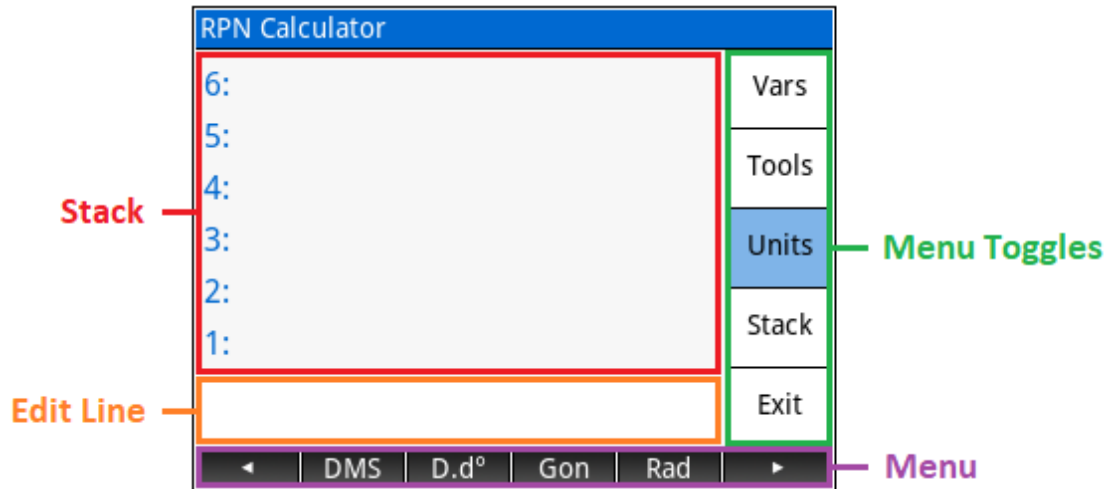



Use the **touch screen** to:

- ▶ Select an object on the stack
- ▶ Open the Edit Line
- ▶ Toggle the current menu
- ▶ Execute a menu option

The **Keyboard** keys have common functions assigned:

- ▶ to DUP Level 1 of the stack
- ▶ or to SWAP Level 1 and 2 of the stack. Moves the cursor when the Edit Line is open.
- ▶ to DROP Level 1 of the stack. + clears the stack.
- ▶ to exit the application, cancel the Edit Line, or unselect a stack object.
- ▶ or to scroll through the stack. + or jumps to the top or bottom level of the stack. When no object is selected on the stack, opens the Edit Line.
- ▶ and to UNDO the previous action. Only one level of UNDO is possible.
- ▶ / / + to toggle the **Vars** / **Tools** / **Units** menus.
- ▶ + to store a variable, more details in the **Vars** menu section.

## Stack Area

The Stack Area displays six levels of the stack. Stack objects can be selected by using the touch screen or the  and  keys. The stack will scroll up and down as required.

When a stack object is selected, the menu will always change to the following options:

**EDIT** Edit the selected value. When editing is complete, the value remains selected.

**STRIP** Strip any associated unit from the object.

**COPY** Copy the object to the Clipboard.



**ECHO** Echoes the selected object to the Edit Line. When editing is complete, the previous stack selection is no longer selected.

**PICK** Pick the selected object and copy it to Level 1 of the stack. The object remains selected on the stack.

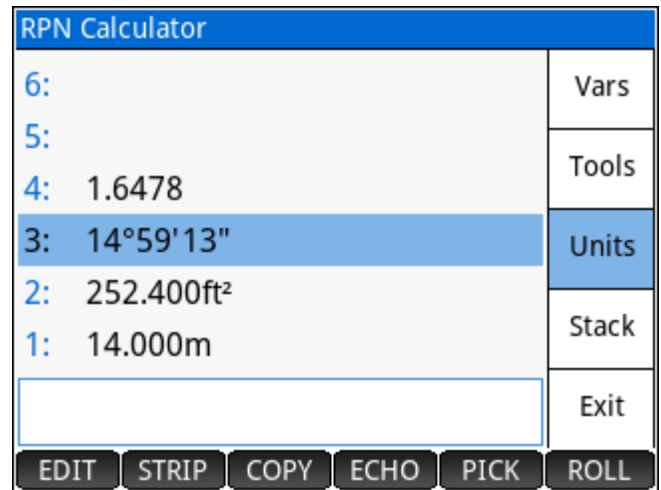
**ROLL** Roll the selected object down to Level 1 of the stack. The stack level of the selection is not changed.



## Edit Line

The Edit Line displays the value being entered or edited and is also used to display any status or error messages. When the Edit Line is open; the menu updates with the primary angle and distance units to assign to the entered value, and **Cancel** and **OK**. Copy and Paste are available with **Shift** and , and **Shift** and .

NOTE: It is possible to enter feet, inches, fractions in the [specified comma-delimited format](#). The current distance unit will automatically be applied to the value entered. The unit conversion happens automatically if required.

## Menu Toggles

Four different menus are available within the app for specific tasks; the menu toggles change the current menu or group of menus.

## Menus

### Vars Menu

The **Vars** Menu displays all the variables stored on the HP Prime as **HVars**. The first and last menu keys are used to change the page of the menu while the middle four keys show the names of the variables.



- ▶ Tap any of the keys to pop the variable's content onto Level 1 of the stack.
- ▶ Press **Shift** and then tap any of the keys to store the value on Level 1 of the stack into the variable.
- ▶ Enable **ALPHA** mode and then **0** followed by the menu key to quote a variable name. Use the **PURGE** option from the Tools menu to purge the quoted variable.
- ▶ Press **Shift** + **EEX** to store a variable. If Level 1 is a string then it will be used as the variable name to store object on Level 2, otherwise prompts for a variable name to store Level 1.
- ▶ Type the variable name (without quotes) followed by **Enter** to recall the variable contents.
- ▶ When storing or recalling a variable, any associated units are kept intact (with the exception of the Links distance unit).

### Tools Menu

- EDIT** Edit Level 1 of the stack.
- STRIP** Strip any associated unit from the object on Level 1 of the stack.
- STO** Stores the object on Level 2 of the stack into the variable name on Level 1 of the stack. When Level 1 is not a string, then a touchscreen keypad opens to enter a variable name.
- PURGE** Purges the variable name on Level 1 of the stack from memory. When Level 1 is not a string, then a list of variables is shown, and the variable can be chosen to be purged.
- P<>R** Toggles between rectangular and polar display modes of vectors.

Requires a vector on Level 1 of the stack.

- >V>** Compiles a vector from stack objects or explodes a vector if Level 1 contains a vector.

To build a vector; Level 1 of the stack needs to be a 2 or 3 to specify the dimension (2D or 3D) and levels above must contain either the rectangular or polar components of the vector.

Exploding a vector results in vector components on the stack and a 2 or 3 on Level 1 of the stack indicating if it was a 2D or 3D vector.

## Units Menu

Four pages of the **Units** menu exist. The first and last menu keys on each page are used to change the page of the menu. The four menus are

- ▶ Angle Units      ◀ DMS D.d° Gon Rad ▶
- ▶ Distance Units    ◀ m ft lks ch ▶
- ▶ Area Units        ◀ m<sup>2</sup> ft<sup>2</sup> ha Ac ▶
- ▶ Volume Units     ◀ m<sup>3</sup> ft<sup>3</sup> yd<sup>3</sup> ▶

Units can be assigned to any value as it is typed, is on Level 1 of the stack or is selected on the stack. Unit conversions are single tap if the existing value is unit-less or is of the same type of unit.

## Stack Menu

- DUP** DUPLICATE Level 1 of the stack. {... 3 2 1} to {... 3 2 1 1}
- SWAP** SWAP Level 1 and Level 2 of the stack. {... 3 2 1} to {... 3 1 2}
- DROP** DROP Level 1 of the stack. {... 3 2 1} to {... 3 2}
- OVER** Copy OVER Level 2 and place it on Level 1 of the stack. {... 3 2 1} to {... 3 2 1 2}
- ROT** ROTate the bottom three levels of the stack. {... 3 2 1} to {... 2 1 3}
- UNROT** UNROTate the bottom three levels of the stack. {... 3 2 1} to {... 1 3 2}

## Vector objects

2D and 3D vectors are supported.

- ▶ Use **Shift** +  $\left[ \begin{array}{c} 5 \\ \text{v} \end{array} \right]$  to open the vector entry form where a rectangular or polar vector can be entered.
- ▶ Use **Shift** +  $\left[ \begin{array}{c} \times \\ \text{x} \end{array} \right]$  to convert the vector on Level 1 of the stack between polar and rectangular display modes.
- ▶ Vectors can be added or subtracted, and multiplied or divided by a scalar.

## 6.5 Configure Settings

See the [User Settings](#) chapter.

# 7 Points Menu

- ▶ [Store and Edit Points](#) – Store new points in the current project database or edit the coordinates and description of an existing point.
- ▶ [Delete Points](#) – Delete points from the current project database.
- ▶ [Rename Points](#) – Rename a range of points using a New Starting Number scheme or an Additive Number scheme.
- ▶ [Plot Points](#) – Graphically display the points in the current project. Zoom and pan functionality is available with all points in the current project, or a specified range of points.
- ▶ [Import / Export](#) – **Import ASCII Points**, **Export ASCII Points** and **Export DXF Points**.

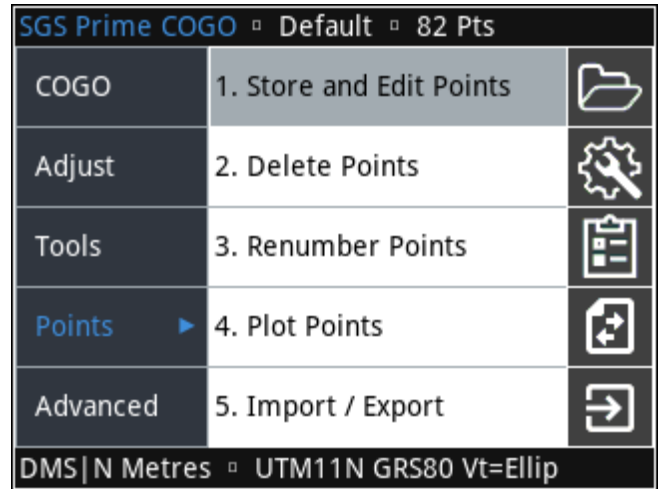

## 7.1 Store and Edit Points

It is possible to store and edit points in the same input form.

### Point ID

Enter a Point ID to edit its coordinates or to store a new point. The coordinate and description fields automatically populate with existing coordinates and description if the point exists.

Options while editing this field:

- Low** Search for the lowest unused point number in the job.
- Next** Search for the lowest unused point number starting from the current value.

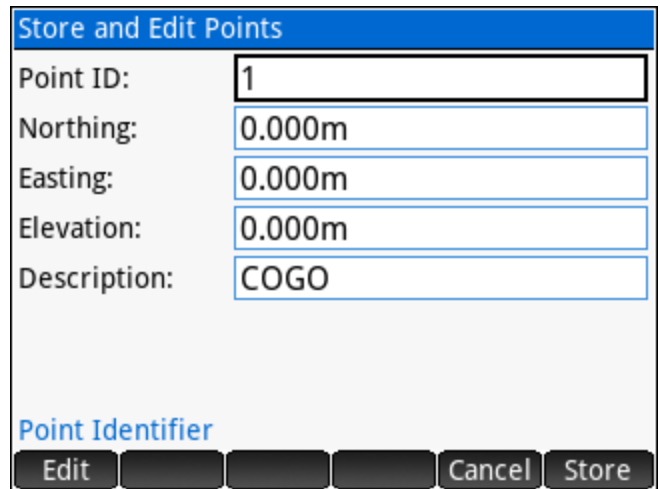

## 7.2 Delete Points

Delete individual points, a range of points or all the points from the current job. To delete individual points or ranges of points, enter points using any of the [point numbers](#) input options.

Check the **All Points** checkbox to delete all points.

The screenshot shows a dialog box titled "Delete Points" with a blue header. Below the header, there is a label "Point(s):" followed by a text input field. Below that is a label "All Points:" followed by an unchecked checkbox. At the bottom of the dialog, there is a blue instruction text: "Enter Point(s) to Delete (#..#, #, #..#)". Below the instruction text, there is a row of buttons: "Edit", a greyed-out button, another greyed-out button, "Cancel", and "Delete".

## 7.3 Renumber Points

Two methods are available for point renumbering.  
Neither method overwrites conflicting point numbers.

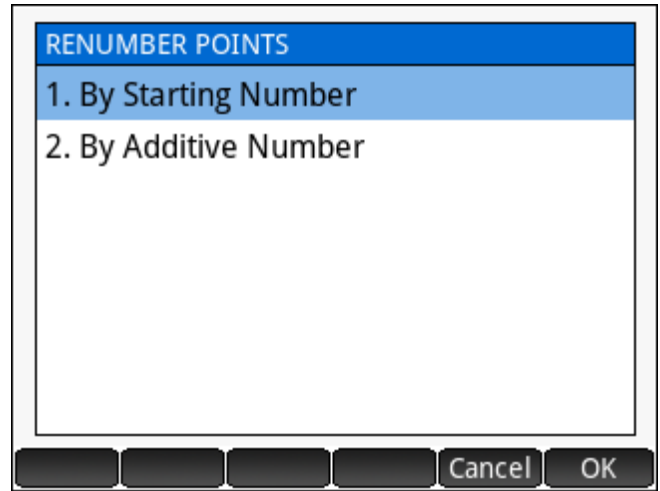

### By Starting Number

Enter the New Starting Point ID to use for renumbering.  
The points' new numbers will begin at this starting number, or in the case where the provided starting number exists, the next available number.

Enter the points to be renumbered using any of the [point numbers](#) input options or check the **All Points** checkbox to renumber all the points in the current project.

Some examples to illustrate this method of renumbering points:

1. When a new starting point number is given as 101, and existing points 1 to 4 are to be renumbered, Point 1 becomes 101, 2 becomes 102, etc.
2. Same as above but in fact there already exists a Point 101, then Point 1 becomes 102, 2 becomes 103, etc.
3. Same as above but there is no Point 3, then 1 becomes 101, 2 becomes 102, and 4 becomes 103.

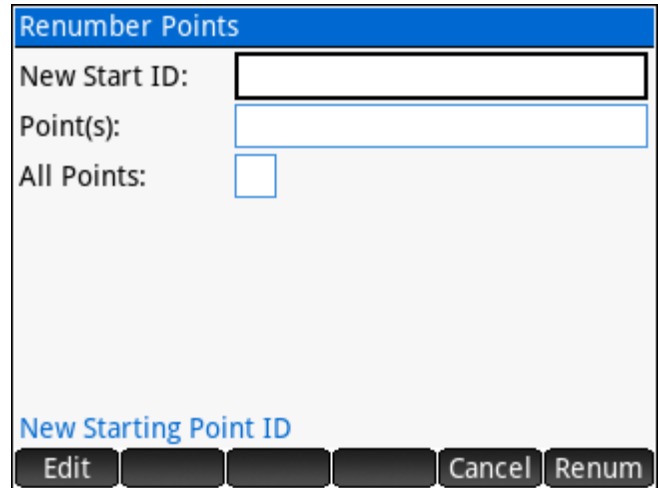

## By Additive Number

Enter an additive number to add to existing point numbers as a renumbering method. In the case where this added number creates a point number that already exists, the next available number will be used.

Enter the points to be renumbered using any of the [point numbers](#) input options or check the **All Points** checkbox to renumber all the points in the current project.

Some examples to illustrate this method of renumbering points:

1. When an additive number is given as 100, and existing points 1 to 4 are to be renumbered, Point 1 becomes 101, 2 becomes 102, etc.
2. Same as above but in fact there already exists a Point 101, then Point 1 is NOT renumbered, 2 becomes 102, etc.
3. Same as above but there is no Point 3, then 1 becomes 101, 2 becomes 102, and 4 becomes 104.

Always ensure that the range of numbers you wish to use are not already in use.

The screenshot shows a dialog box titled "Renumber Points". It contains three input fields: "Additive #:" (a text box), "Point(s):" (a text box), and "All Points:" (a checkbox). Below these fields is a blue link that says "Additive Number to Add to Point IDs". At the bottom of the dialog, there is a row of buttons: "Edit", a disabled button, a disabled button, "Cancel", and "Renum".



## 7.4 Plot Points



Plot Points by default will display all points in the current project. The initial map view is zoomed to fit all the points on the screen. Point range filters can be applied to limit the points that are displayed.

Keyboard and touch navigation are possible.

### Using Touch

- ▶ Drag to Pan
- ▶ Pinch to Zoom
- ▶ Tap to Center on the tap location

### Using the Keyboard

- ▶ Cursor keys to pan (▲/▼) and (◀/▶)
- ▶  and  to Zoom

### Using the Menu

- Filter** Set a point range filter
- Find** Find a specific point and center on it
- Extent** Zoom Extents
- PtID** Toggle to display the Point ID
- Desc** Toggle to display the Point Description
- Close** Close the Plot Points screen

Access Plot Points from any input form or the main menu by using the  key on the keyboard.

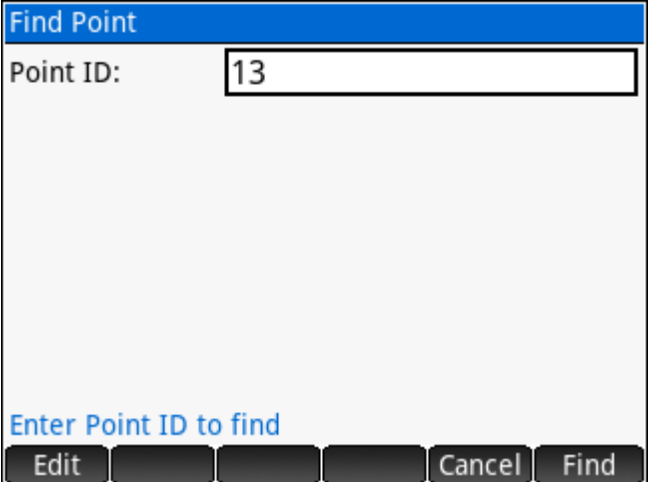
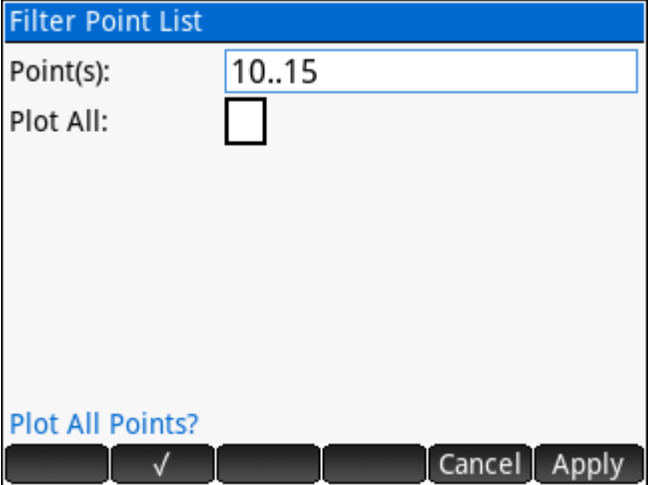
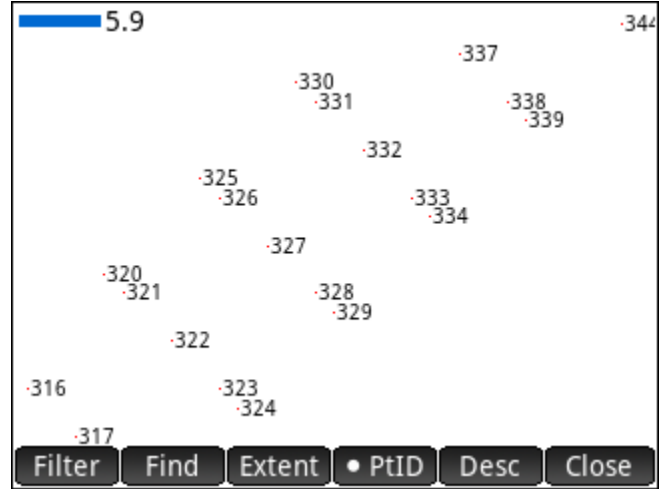

## 7.5 Import/Export

Import and Export files containing Point data from/to the App Files on the Prime calculator.

### Import Points

Import a delimited ASCII points file into the current project database. The file must be present within the App Files section of the **SGS Prime COGO** app and must have one of the following extensions:

- ✓ .asc **ASC**ii text file
- ✓ .csv **Comma Separated Values**
- ✓ .txt **TeXT** file
- ✓ .pts STAR\*NET point coordinates
- ✓ .gnd STAR\*NET ground coordinates

First, select the format and delimiter of the ASCII file you wish to import. **NOTE: THIS STEP IS CRITICAL TO ENSURE THAT THE DATA IS STORED CORRECTLY.**

Select an ASCII file from the list to import.

The selected file is parsed line by line and the coordinates are stored if valid data is found. Point number conflicts result in a screen showing the coordinate differences and **YES/NO/YES TO ALL/NO TO ALL** options to overwrite the existing point(s). The import progress is displayed while the file is processed, and the total number of points added or modified in the project database is reported when import is completed.

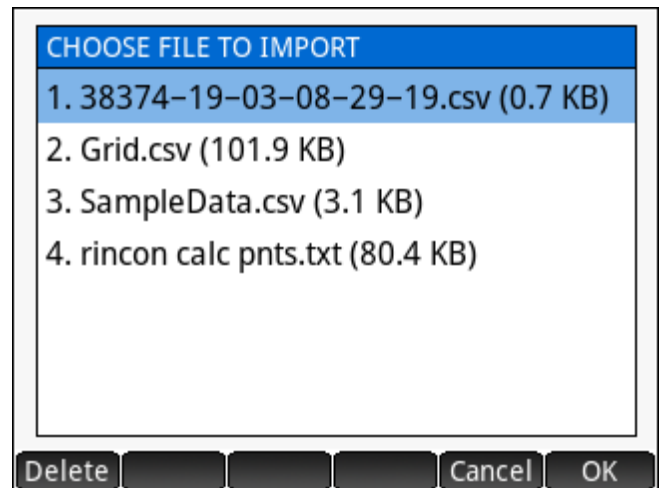
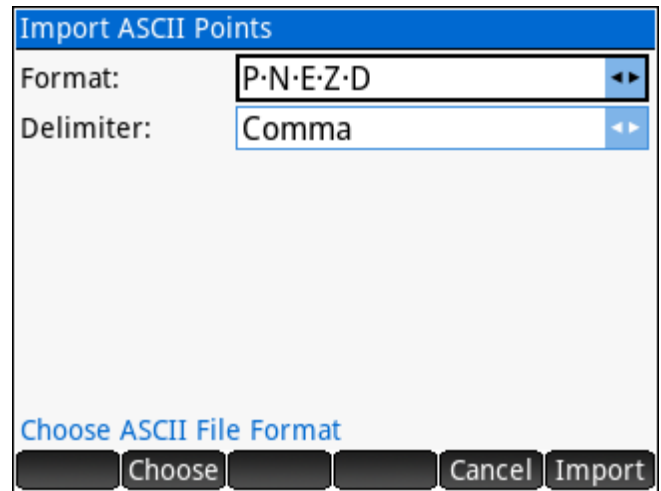
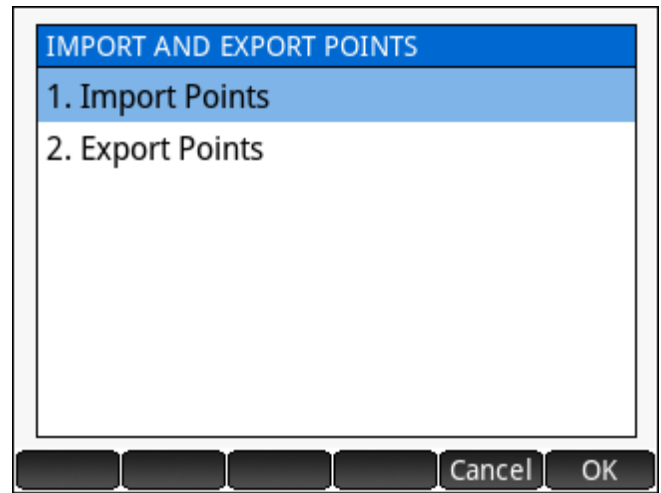

During Import, lines starting with the # character are ignored.

## Export Points

Points can be exported in ASCII, DXF or KML format. Each of the three options are available as a page within the main input form.

### Export ASCII Points

Write a delimited ASCII points file of points in the current project for archiving or importing into CAD software on your PC, or any number of other possible uses.

Select the ASCII file format, the delimiter and the number of decimals to export.

Enter a file name to save the exported points and choose the file extension. By default; the file name will be populated with the current project name, and the file extension will be set to the previously used extension.

Enter the points you wish to export using any of the [point numbers](#) input options, or optionally select **All Points** to export all points.

The export progress is displayed while the program is working, and the total number of points exported is displayed when complete.

When a file name conflict is encountered, the option to overwrite the existing file is given.

**NOTE:** The available number of decimals for selection ranges from 0 to 8, however the calculator is capable of a maximum of 12 digits for real numbers. The actual number of decimals may not be possible when point coordinates are stored in higher numerical ranges.

Format:	P·N·E·Z·D	ASCII
Delimiter:	Comma	
Decimals:	4	
File Name:	Default .csv	DXF
Point(s):		
All Points:	<input type="checkbox"/>	KML

[Choose ASCII File Format](#)

Choose Cancel Export

## Export DXF Points

Write a DXF file (ASCII format) of points in the current project to open with CAD software on your PC.

Select the items to export. Point nodes are always exported, but the text attributes of the points are optional.

Specify the text height for the text attributes. By default, for metric projects the text height will be suggested as 1.0, and for imperial projects the text height will be suggested as 3.0.

Export DXF Points	
Point IDs: <input checked="" type="checkbox"/>	ASCII
Descriptions: <input checked="" type="checkbox"/>	
Elevations: <input checked="" type="checkbox"/>	
Text Height: 1.0	DXF
File Name: Default .dxf	KML
Point(s):	
All Points: <input type="checkbox"/>	
<a href="#">Export Point ID Text?</a>	
[Checkmark] [Cancel] [Export]	

Enter a file name to save the exported points. By default; the file name will be populated with the current project name.

Enter the points you wish to export using any of the [point numbers](#) input options, or optionally select **All Points** to export all points.

The export progress is displayed while the program is working, and the total number of points exported is displayed when complete.

When a file name conflict is encountered, the option to overwrite the existing file is given.

The point node and text entities will be created using the [DXF File Layers](#) settings.

## Export KML Points

Write a KML file of points in the database so that they can be viewed in Google Earth (or other GIS related software).

Select the icon colour for the icons that the points will be displayed with in Google Earth.

Ensure the correct coordinate system is set, and if necessary, set a transformation to transform the exported points. Available options for transformations include [Ground to Grid](#) and [3 or 7 Parameter](#) transformations.

Export KML Points

Icon Colour: Red

File Name: Default.kml

Point(s):

All Points:

Coord Sys: UTM Zone 11

Transform: No Transformation

Choose point icon colour

Choose Cancel Export

ASCII DXF KML

HINT: Open the KML in Google Earth on your mobile device to take advantage of the “Find” feature which will use the mobile device geo-location to guide you to the point.

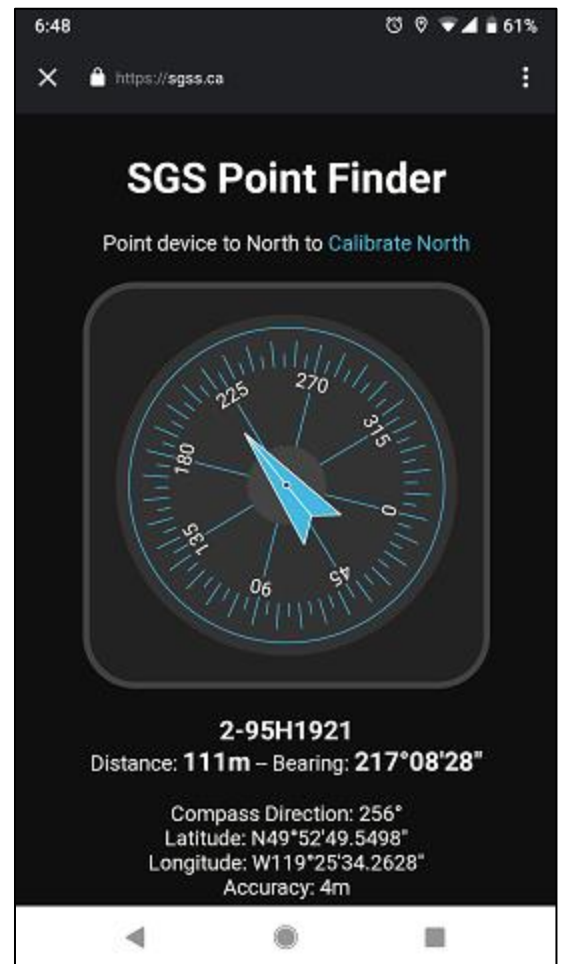

# 8 Advanced Menu

- ▶ [Alignments](#) – Create complex 3D alignments and perform various calculations.
- ▶ [Leveling](#) – Enter and edit level observations, export and perform calculations.
- ▶ [Traverse Plus 3D](#) – Calculate coordinates from field notes, simulate data collection and field calculation procedures.
- ▶ [Coordinate Converter](#) – Convert coordinates between grid, geodetic and cartesian. Convert from one grid projection to another grid projection using 3 or 7 parameter transformations. Convert between grid and ground based on provided parameters.
- ▶ [Ellipsoid Calculations](#) – Calculate DIRECT and INVERSE Computations on the ellipsoid.

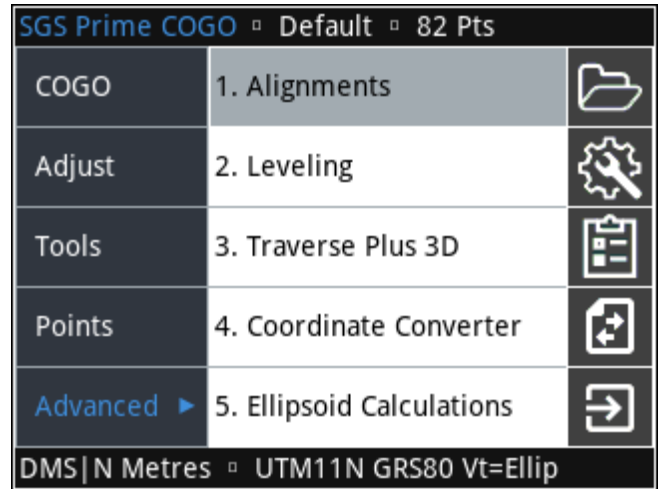

## 8.1 Alignments

**SGS Prime COGO** includes an Alignments program to manage multiple complex 3D alignments. Each alignment consists of horizontal, vertical and cross section components. The horizontal centerline of the alignment is the only mandatory definition for any alignment. Various calculations are possible with alignments.

### Alignment Manager

The Alignment Manager lists all the alignments created, and allows the user to create new alignments, delete existing alignments, or to load an alignment for editing, review and calculations. Available Options:

- New** Create a new Alignment.
- Delete** Delete the selected alignment
- Rename** Rename the selected alignment.
- Load** Load the selected alignment.

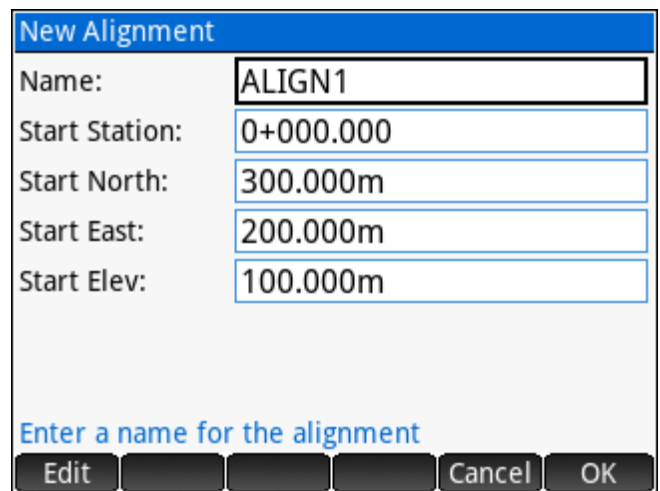
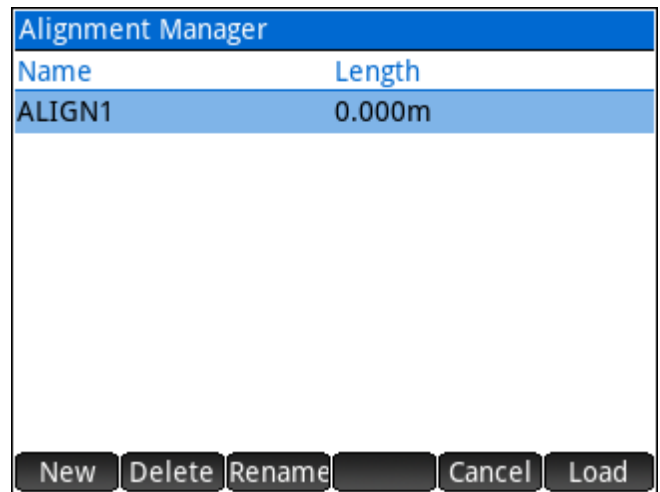

## Defining an Alignment

The interface features 5 tabs on the right edge of the screen; each tab allowing the user to edit different components of the alignment. Within each tab, the defined segments are displayed, and the menu provides access to all the functionality. The menu is common across the tabs.

- Edit** Edit the selected segment.
- Delete** Delete the selected segment.
- Info** Display more information about the selected segment.
- Calc** Perform Calculations with alignment data.
- Add** Add a new element to the current active component.

### Horizontal Alignment

A new alignment is created by default to have a starting station of 0 (displayed as 0 or 0+00 or 0+000 depending on the user setting) and starting coordinates of 0,0. These parameters can be edited at any time; the entire horizontal alignment is updated to reflect any starting point station and coordinates changes.

Edit Horizontal Alignment			
Segment	Station	Length	
1 Start	0+000.000	--	Horiz
2 End	0+000.000	--	Vert
			Xsec
			Eqs
			Xtemp

Edit Delete Info Calc Cancel Add

### Add Horizontal Segment

With the Horizontal Alignment tab active, use the **Add** button or **Enter** to add a new horizontal segment. All segments are added to the end of the list of already defined segments. The end coordinates of the existing alignment are used as the starting coordinates for the new segment. The available options for horizontal segments are:

- ▶ Straight
- ▶ Curve, and
- ▶ Spiral-Curve-Spiral.

ADD HORIZONTAL SEGMENT
1. Straight
2. Curve
3. Spiral-Curve-Spiral

Cancel OK

### *Horizontal Straight*

Horizontal Straight segments may be defined using one of three methods:

1. Direction and Length
2. Direction and End Station, or
3. End Coordinates

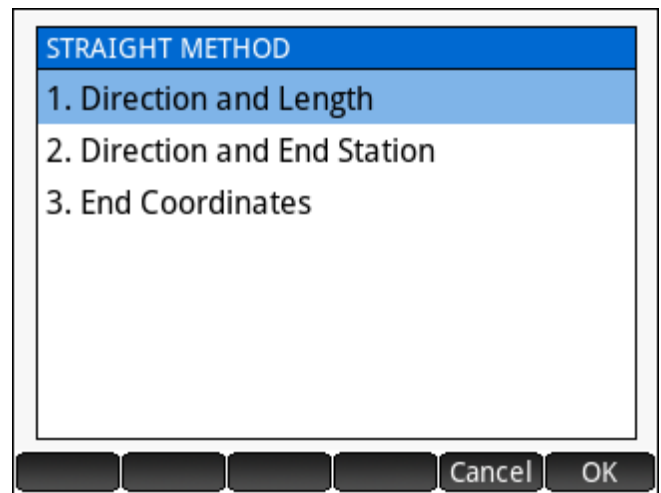

### *Horizontal Curve*

Horizontal Curve segments may be defined using one of eight methods:

1. Radius and Length
2. Radius and Delta
3. Radius and PI Station
4. Radius and EC Station
5. Radius and PI Coordinates
6. Radius and EC Coordinates
7. CC and PI Coordinates
8. CC and EC Coordinates

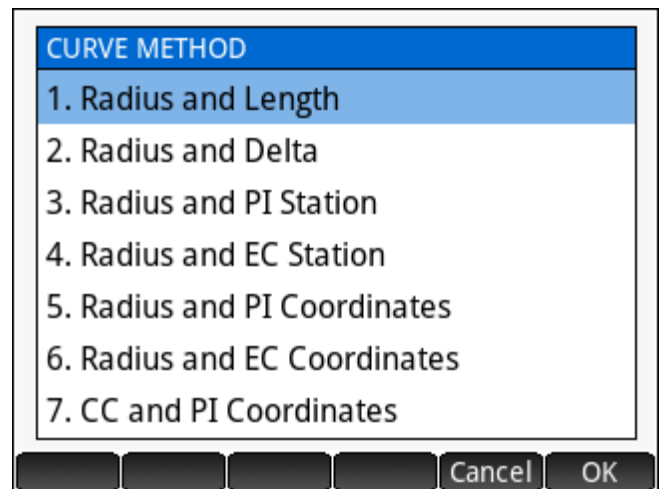

NOTES: Methods 1-4 also require the “Tangent In” direction, which is automatically calculated from the previous element. Methods 1-6 also require the curve direction, left or right. For all radius fields, a “Degree of Curve” option is available to calculate the radius from the Degree of Curve, arc or chord definition.



### Horizontal Spiral-Curve-Spiral

Horizontal Spiral-Curve-Spiral segments may be defined using one of five methods:

1. Curve Radius and Length
2. Curve Radius and Delta
3. Curve Length and Delta
4. Curve Radius and PI Station
5. Curve Radius and PI Coordinates

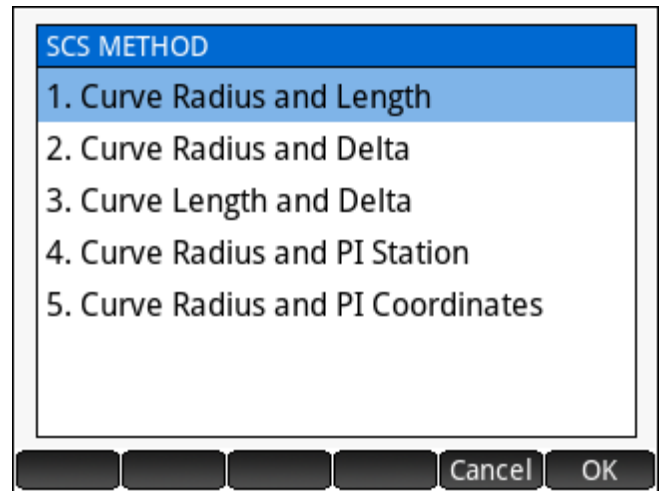

NOTES: The curve radius refers to the radius of the circular curve portion. PI station and coordinates refer to the PI of the transition curve, not the circular portion. All methods require the "Tangent In" direction, which is automatically calculated from the previous element. All methods require the curve direction, left or right. For all radius fields, a "Degree of Curve" option is available to calculate the radius from the Degree of Curve, arc or chord definition.

### Edit Horizontal Segment

Touch **Edit** to edit the selected horizontal segment. For each segment type, straight, curve or SCS, the same options are available as when adding a new segment. The current values are automatically inserted into the input form regardless of which method is chosen.

When edits are made to a segment, the segment itself is updated, and any segments following the edited segments are also updated. A prompt allows the user to choose whether to update the position only, or the position and rotation of any trailing segments.

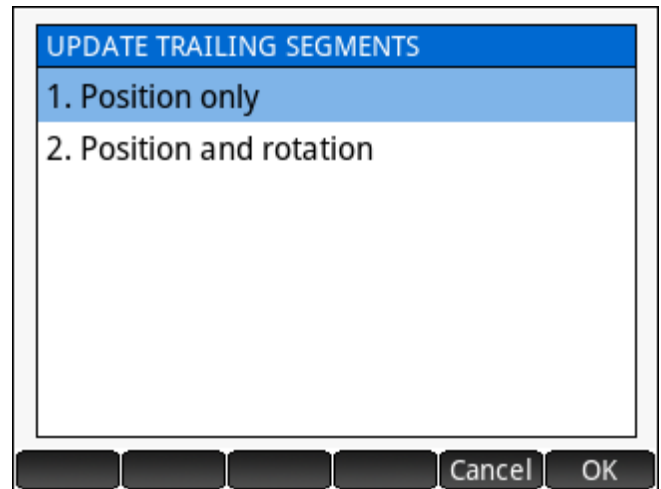

### Delete Horizontal Segment

Touch **Delete** to delete the selected horizontal segment. When a segment is deleted, all segments following the deleted segment are shifted to join the segment preceding the deleted segment. Where applicable; the option to update position or position and rotation is presented.

## Vertical Alignment

Generally, the vertical alignment is defined after the horizontal alignment and the extents of the vertical alignment match the horizontal alignment, however a vertical alignment may start and end within or outside the parameters of the horizontal alignment. By default, the vertical alignment is defined to start at Station 0 and Elevation 0. These parameters may be edited at any time.

Edit Vertical Alignment			
Segment	Station	Length	
1	Start	0+000.000	--
2	End	0+000.000	--

Buttons: Edit, Delete, Info, Calc, Cancel, Add

## Add Vertical Segment

With the Vertical Alignment tab active, use the **Add** button or  to add a new vertical segment. All segments are added to the end of the list of already defined segments. The end elevation of the existing vertical alignment is used as the starting elevation for the new segment. The available options for vertical segments are:

- ▶ Straight, or
- ▶ Curve (Parabola)

**ADD VERTICAL SEGMENT**

1. Straight
2. Curve (Parabola)

Buttons: Cancel, OK

### Vertical Straight

Vertical Straight segments may be defined using one of four methods:

1. Length and Grade
2. End Station and Grade
3. Length and End Elevation
4. End Station and End Elevation

NOTES: For each method, the length or end station field is automatically set to match the end of the horizontal alignment. Grade values are automatically determined from the preceding segment.

**STRAIGHT METHOD**

1. Length and Grade
2. End Station and Grade
3. Length and End Elevation
4. End Station and End Elevation

Buttons: Cancel, OK

### Vertical Curve (Parabola)

Vertical Curve segments may be defined using one of four methods:

1. Length and Grades
2. EVC Station and Grades
3. Length and Elevations
4. EVC Station and Elevations

NOTES: For each method, the length or end station field is automatically set to match the end of the horizontal alignment. Entry grade values are automatically determined from the preceding segment.

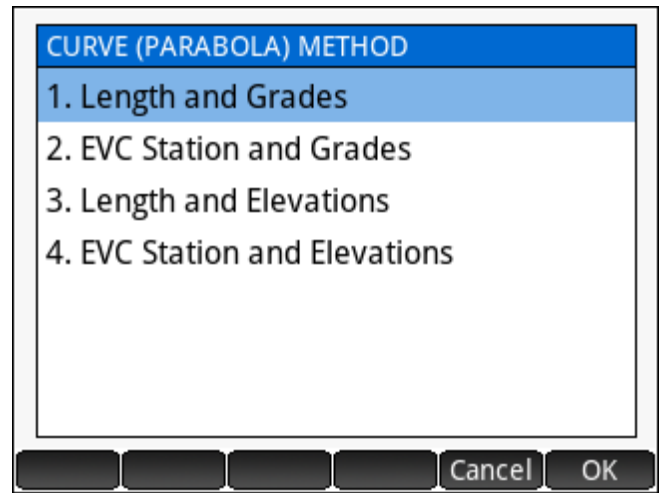

#### Edit Vertical Segment

Touch **Edit** to edit the selected vertical segment. For each segment type, the same options are available as when adding a new segment. The current values are automatically inserted into the input form regardless of which method is chosen.

When edits are made to a segment, the segment itself is updated, and any segments following the edited segments are also updated by moving its start/end stations to keep a continuous vertical alignment without overlaps or gaps.

#### Delete Vertical Segment

Touch **Delete** to delete the selected vertical segment. When a segment is deleted, all segments following the deleted segment are shifted to join the segment preceding the deleted segment.

## Cross Section Assignments

Cross section assignments require a cross section template, which can be created from the bottom-most tab labeled "Xtemp". Cross section assignments are dependent on the vertical alignment. When a vertical alignment is not defined for a station, the cross-section assignment will be ignored for the station when performing any calculations.

Edit Cross Section Assignments			
Start Station	End Station	Template	
0+000.000	0+414.220	XSTEMP1	
			Horiz
			Vert
			Xsec
			Eqs
			Xtemp

Buttons: Edit, Delete, Info, Calc, Cancel, Add

## Add Cross Section Assignment

With the Cross-Section Assignment tab active, use the **Add** button or **Enter** to add a new assignment.

To add a new assignment; specify the start and end station for the assignment and choose a pre-defined template to assign to the range of stations.

Assignments are chained together, therefore a second or subsequent assignment will only allow the end station to be edited.

Add Cross Section Assignment	
Start Station:	0+000.000
End Station:	0+414.220
Template:	XSTEMP1

Enter the Starting Station

Buttons: Edit, Cancel, OK

## Edit Cross Section Assignment

Touch **Edit** to edit the selected assignment. The current values are automatically inserted into the input form.

When edits are made to an assignment, the assignment itself is updated, and any assignments following the edited assignment are also updated by moving its start/end stations to keep a continuous chain without overlaps or gaps.

## Delete Cross Section Assignment

Touch **Delete** to delete the selected assignment. When an assignment is deleted, all assignments following the deleted assignment are shifted to join the assignment preceding the deleted assignment.

## Station Equations

Station equations are used to change the stationing at key points, often where the alignment meets another alignment. A station equation consists of a Station Back and Station Ahead. The Station Back is the chainage of the alignment up to that point, and the Station Ahead is the chainage that is adopted moving ahead.

NOTE: Station Equations should be defined first if other components of the alignment will be defined with the modified stationing.

### Add Station Equation

With the Station Equation tab active, use the **Add** button or  to add a new equation.

To add a new equation, specify the station back and station ahead.

Equations should be entered in sequence if multiple equations exist. It is up to the user to ensure the order and definition is correct. Once created, station equations will impact stationing input and output.

**Add Station Equation**

Station Back: 0+200.000

Station Ahead: 0+350.000

Enter the Station Back

Edit [Greyed Out] [Greyed Out] Cancel OK

### Edit Station Equation

Touch **Edit** to edit the selected equation. The current values are automatically inserted into the input form.

Only the selected equation is impacted, there is no relationship between separate equations.

### Delete Cross Section Assignment

Touch **Delete** to delete the selected equation. No changes will occur to any remaining equations.

## Cross Section Templates

Cross section templates are used to define cross sections of alignments and can be re-used unlimited times once created. The cross-section template manager lists all the templates created. New templates can be created, and existing templates can be deleted or edited. The menu provides access to the operations described below.

Edit Cross Section Templates		
Template	Segments	
XSTEMP1	0	Horiz
		Vert
		Xsec
		Eqs
		Xtemp
Edit Delete Info Calc Cancel Add		

### Add Cross Section Template

With the Cross-Section Template tab active, use the **Add** button or **Enter** to add a new template.

A name is required to create a new template.

### Edit Cross Section Template

Touch **Edit** to edit the selected cross section template. The Template Editor opens to edit the template.

### Delete Cross Section Template

Touch **Delete** to delete the selected template. It is not possible to delete a template currently assigned to an alignment.



### *Delete Offset Segment*

Touch **Delete** to delete the selected offset segment. Only the left-most or right-most segments may be deleted.

### *Plot Template*

Touch **Plot** to plot the template cross section.

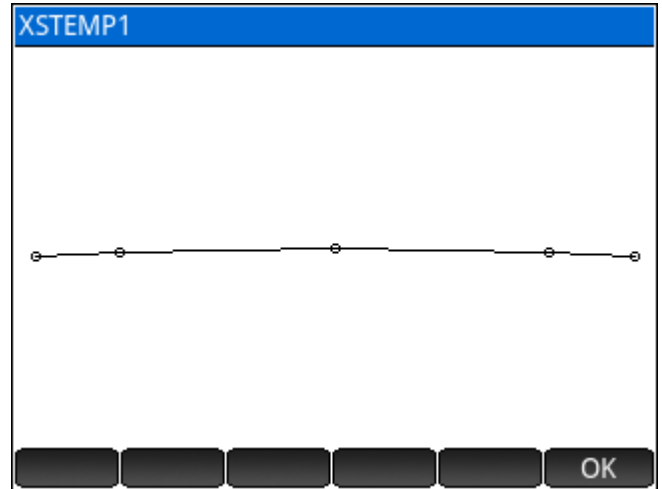



## Alignment Calculations

When an alignment has been defined, the alignment definition can be used for:

- ▶ Solve Station and Offset – By entering any station and offset along the alignment, the 3D coordinates of the point are solved.
- ▶ Coordinates by Interval – Specify a station interval to calculate 3D points at each interval along the alignment.
- ▶ Inverse Points to Alignment – Calculate the station, offset and cut/fill of any point in the current project relative to the alignment.
- ▶ Plot Horizontal Alignment – Draws the horizontal alignment on the screen.
- ▶ Plot Vertical Alignment – Draws the vertical alignment on the screen.
- ▶ Export LandXML – Writes a LandXML file of the alignment.

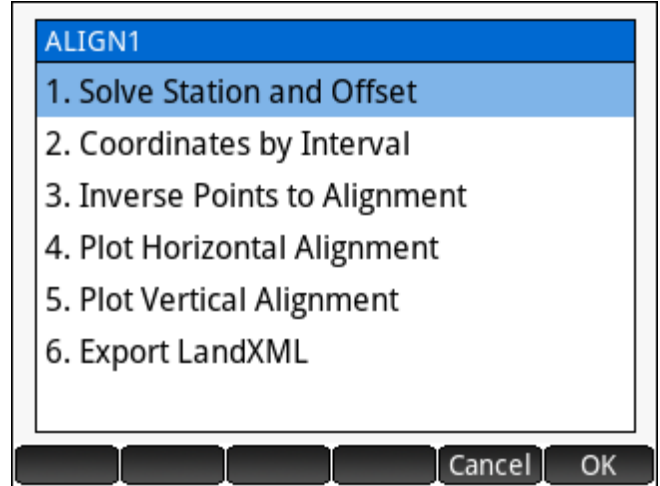

### Solve Station and Offset

Simply enter the station and offset to solve the coordinates.

Solve Station and Offset

Station: 0+335.100

Offset: 1.750m

Enter Known Station

Edit Cancel Solve

Solve Station and Offset

Station: 0+335.100

Offset: 1.750m

North: 369.988m  
East: 502.082m  
Elev: 118.455m

Enter Known Station

Store OK

Use the **Store** option to store the coordinates as a point in the current project.



### Plot Horizontal Alignment

Draws the horizontal alignment on the screen.

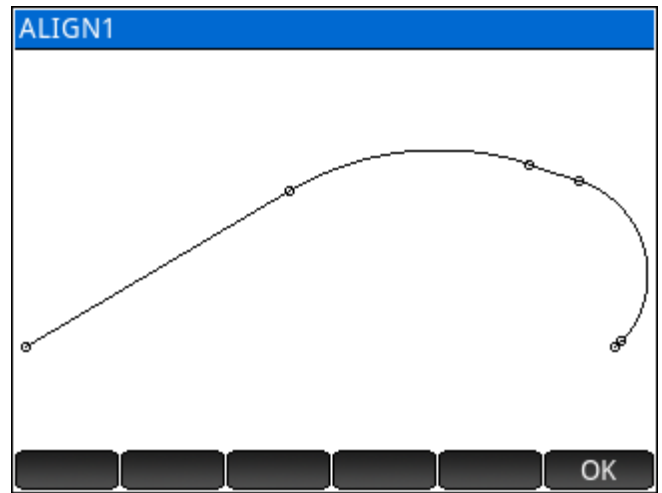

### Plot Vertical Alignment

Draws the vertical alignment on the screen.

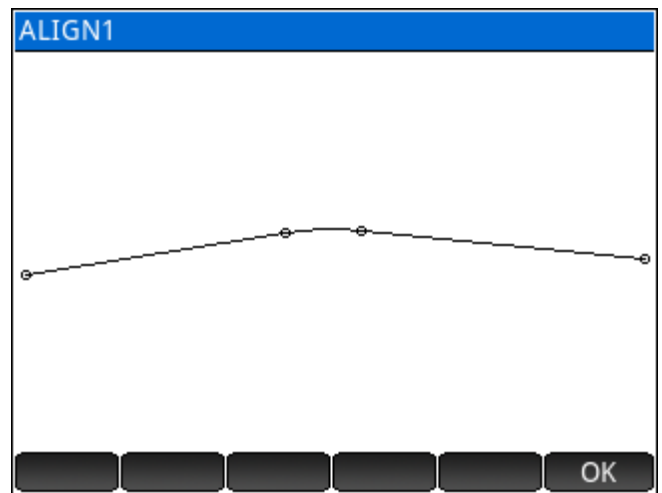

### Export LandXML

Specify a name for the XML file to export the alignment definition in LandXML format.

Many software packages can read the LandXML files, see <http://landxml.org/> for more information on the LandXML schema.

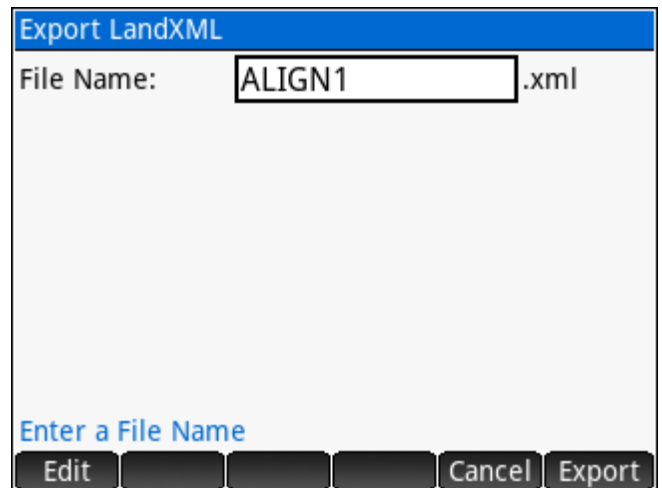

## 8.2 Leveling

**SGS Prime COGO** includes a Leveling program to manage multiple leveling projects. Each project consists of backsight, foresight and intermediate foresight observations. Edit and review observations and perform calculations such as cuts/fills using observed data.

### Leveling Project Manager

The Project Manager lists all the Leveling projects created, and allows the user to create new projects, delete existing projects, or to load a project for edits and calculations. Available Options:

Level Projects	
Project Name	Observations
No Level Projects created ...	

New [ ] [ ] [ ] [ ] Cancel [ ]

**New** Create a new Project. Enter a name for the project to create a new project and specify the project-specific settings. The project is added to the Project Manager List.

**Delete** Delete the selected project. A confirmation prompt is displayed.

**Edit** Edit the project name and settings.

**Load** Load the selected project.

New Level Project	
Name:	LEVEL1
Distances:	Enter Distances <>
Default Dist.:	30.000m
Turn Points:	TP
Format:	STA·BS·HI·FS·IFS·ELEV <>

Distance Observations

[ ] Choose [ ] [ ] Cancel [ ] OK

Level Projects	
Project Name	Observations
LEVEL1	0

New Delete Edit [ ] Cancel Load

Projects can be created with option to use default distances or to require entered distances to observed stations. Turn Point prefixes can be customized for the job.

## Working with a Leveling Project

New projects contain no observations or data, therefore some of the options are not available until enough data has been entered.

The interface displays the observation data entered and the menu provides access to all the functionality.

- Edit** Edit the selected observation.
- Delete** Delete the selected observation.
- Data** Review or process the Observation Data.
- Calc** Perform Calculations from project data.
- BS** or **FS** Enter a backsight or foresight observation.

LEVEL1 Observations			
Reading	Station	Rod	Hz Dist
No Observations ...			

Buttons: [ ] [ ] [ ] [ ] [Cancel] [BS]

### Entering the Initial Backsight

The first observation of any Leveling project is the initial backsight observation. The elevation of the initial backsight is required; however, it can be edited later if needed.

Level Start	
Station:	23-011
Elevation:	233.904m
Backsight:	2.023m
Distance:	50.000m
Description:	CWBM 23-011

Starting Station

Buttons: [Edit] [ ] [ ] [ ] [Cancel] [OK]

LEVEL1 Observations			
Reading	Station	Rod	Hz Dist
1 BS	23-011	2.023m	50.000m

Buttons: [Edit] [Delete] [Data] [Calc] [Cancel] [FS]

## Entering Foresights

When entering foresights, toggles are available to specify the station as an Intermediate Foresight (IFS) or a Turn Point. Leaving both toggles unchecked specifies a Network Foresight Station.

### Intermediate Foresights

A Station name is still required; however, the BS / FS action of the menu will remain as FS. All intermediate foresights are entered before the observation to the Network Foresight Station.

### Turn Points

Turn Points are automatically given a "TPx" name, where x starts at 1 and increments at each Turn Point. Turn Points are generally temporary locations for the sake of carrying on a Level Run. Turn Point stations are not selectable for Cut/Fill calculations, etc.

**Observe Foresight**

Foresight:

Distance:

Intermediate:

Station:

Turn Point:

Description:

Intermediate Foresight?

**Observe Foresight**

Foresight:

Distance:

Intermediate:

Station:

Turn Point:

Description:

Foresight to Turn Point?

## Entering Backsights

The Station name is not editable when entering a Backsight observation.

**Observe Backsight**

Backsight:

Distance:

Station:

Approximate Hz Distance to Backsight

**LEVEL1 Observations**

Reading	Station	Rod	Hz Dist
1	BS 23-011	2.023m	50.000m
2	FS TP1	1.597m	50.000m
3	BS TP1	1.446m	50.000m

## Deleting Observations

The selected observation may be deleted, if it is either:

1. An Intermediate Foresight observation, or
2. The very last observation entered

A confirmation prompt is displayed prior to deletion. An error message is displayed when the observation cannot be deleted.

## Observation Data

Review the observation data in a typical field book format, store a Level Station elevation to a point in the current project point database, export a text file of the current field book observations, or export a STAR\*NET format data file for a Least Squares adjustment using STAR\*NET.

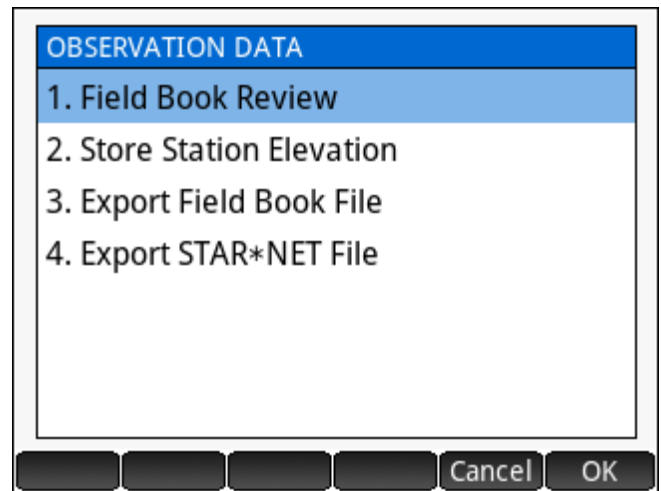

## Field Book Review

Displays the observation data like how it would be entered in a field book.

A screenshot of a software window titled "Field Book Review". The window displays a table of observation data. The table has the following columns: STA, BS, HI, FS, IFS, and ELEV. The data is as follows:

STA	BS	HI	FS	IFS	ELEV
23-011	2.023	235.927	--	--	233.904
TP1	1.446	235.776	1.597	--	234.330
TP2	1.584	236.003	1.357	--	234.419
84R511	1.837	236.322	1.518	--	234.485
TP3	0.795	236.297	0.820	--	235.502
TP4	1.545	237.238	0.604	--	235.693
TP5	0.775	236.488	1.525	--	235.713
TP6	1.750	236.681	1.557	--	234.931
TP7	0.185	236.841	0.025	--	236.656

At the bottom of the window, there are several buttons, including "Page", "Cancel", and "OK".

### Export Field Book File

Export the observation data to a text file, formatted like a Field Book. The fieldbook format of the current project  
Four format options are available for order and content of the exported file.

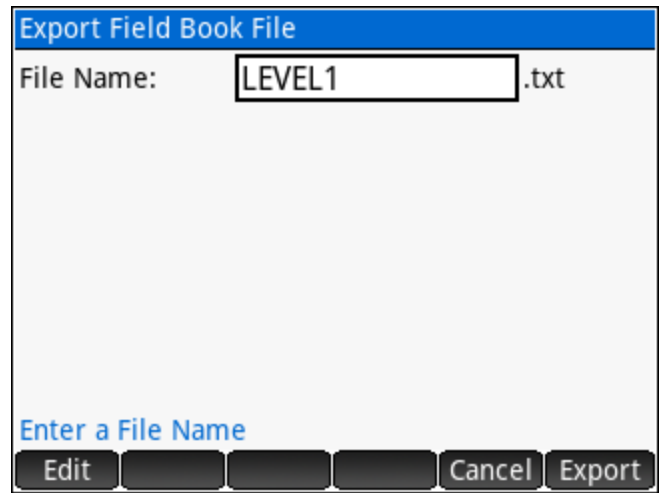

### Sample Output

STA	BS	HI	FS	IFS	ELEV
23-011	2.023	235.927	--	--	233.904
TP1	1.446	235.776	1.597	--	234.330
TP2	1.584	236.003	1.357	--	234.419
84R511	1.837	236.322	1.518	--	234.485
TP3	0.795	236.297	0.820	--	235.502
TP4	1.545	237.238	0.604	--	235.693
TP5	0.775	236.488	1.525	--	235.713
TP6	1.750	236.681	1.557	--	234.931
TP7	0.185	236.841	0.025	--	236.656
TP8	1.720	237.157	1.404	--	235.437
TP9	1.950	237.354	1.753	--	235.404
TP10	0.691	236.318	1.727	--	235.627
TP11	2.078	237.038	1.358	--	234.960
23-013	--	--	1.253	--	235.785



## Export STAR\*NET File

Export the observation data in a STAR\*NET input data format. Any dashes found in station names are replaced with underscore characters to conform with the default STAR\*NET station separator.

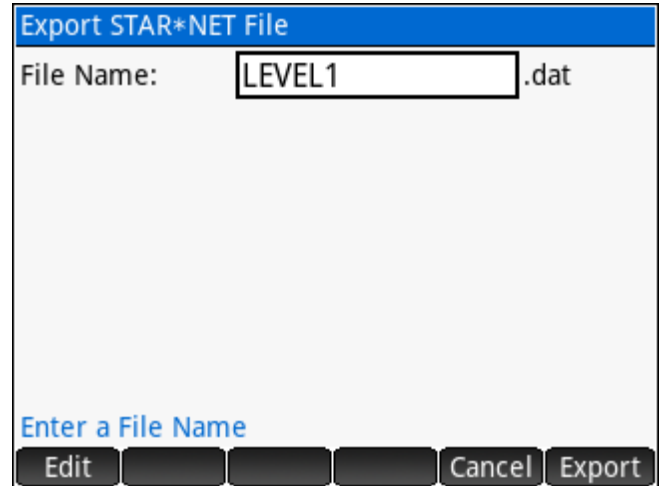

Export STAR\*NET File

File Name: LEVEL1 .dat

Enter a File Name

Edit [ ] [ ] [ ] Cancel Export

## Sample Output

```
# SGS Prime COGO 1.2.x - LEVEL1
# Created July 16, 2018

# Fixed Elevations
E 23_011      233.904 ! 'CWBM 23-011

# Leveling Observation Data
L 23_011-84R511  0.581  300 'GPS MON 84R511
L 84R511-23_013  1.300  1000 'CWBM 23-013
```

## Calculations

Calculate cuts and fills by observing (backsight) a station in the current Leveling project and specifying the design elevation.

In the next input form, enter the rod reading observed to calculate the cut or fill.

The solution displays the cut or fill, and the observed elevation.

Cuts and Fills

BS Station: 84R511 - 234.485m

Backsight: 1.672m

Design Elev: 234.000m

Choose Station to Backsight

Choose Cancel OK

Cuts and Fills

Rod Reading: 1.830m

Target Rod: 2.157m

Design Elev: 234.000m

Instr Height: 236.157m

Foresight Rod Reading

Edit Cancel Solve

Cuts and Fills

Rod Reading: 1.830m

Warning: Cut: -0.327m

Measured Elevation: 234.327m

Foresight Rod Reading

OK

## 8.3 Traverse Plus 3D (BETA)

Traverse Plus 3D in SGS Prime COGO Version 1.5 is released as a BETA. While most of the planned features are included and tested; there are further enhancements planned and more testing required before removing the BETA status. The user is advised to verify results before relying on them.

The primary purpose of this application is to recreate coordinates from field notes or to simulate data collection and field calculation procedures.

Traverse data and settings are specific to the project that is in use. Each project can have its own running traverse, with data and settings saved and restored when closing and opening a project.

A grid of buttons provides access to all functionality of the program, which can also be accessed by using the corresponding numeric key (1-6) on the keyboard.

Traverse Plus 3D (BETA)		
1 Setup	2 Measure	3 Stake
4 Reference	5 Tools	6 Close
OC:? BS:? -- HI:0.000 HT:0.000		

NOTE: See the [Tools](#) section on available settings to configure, prior to getting started.

### Setup

A valid setup is required before measuring or staking is possible. There are four setup methods:

#### Set Azimuth

**Set Azimuth** is useful for the initial setup of a Traverse when control points do not exist. Generally, the Station will be assigned arbitrary coordinates, and an approximate direction to a second point is entered to get started.

Enter an existing Point ID (which can be created if not yet existing) to set the Station and enter the Instrument Height. The coordinates of the station are displayed (greyed out). Continue to the next screen to enter a direction.

Setup Method: Set Azimuth	
Station ID:	101
Instr Height:	1.617m
Northing:	5368970.195m
Easting:	471985.914m
Elevation:	18.737m
Description:	SPK
Existing Station ID	
Edit	Cancel
Cont	

The Backsight Direction is the only required information to complete the setup. Additional measured information may be entered to calculate the coordinates of the Backsight point, and then optionally store the Backsight Point.

Set Azimuth	
Azimuth	0°00'00"
Measure?	<input type="checkbox"/>
Slope Distance:	0.000m
Zenith Angle:	90°00'00"
Target Height:	0.000m
<b>Backsight Direction</b>	
<input type="button" value="Edit"/>	<input type="button" value="Cancel"/> <input type="button" value="Set"/>

Set Azimuth	
Azimuth	0°00'00"
Measure?	<input checked="" type="checkbox"/>
Slope Distance:	93.688m
Zenith Angle:	87°46'37"
Target Height:	1.300m
<b>Backsight Direction</b>	
<input type="button" value="Edit"/>	<input type="button" value="Cancel"/> <input type="button" value="Set"/>

### Known Backsight Point

**Known Backsight Point** is a very common type of setup. In this situation the user sets the station over a known point and sets the orientation to another known point.

Enter an existing Point ID (which can be created if not yet existing) to set the Station and enter the Instrument Height. The coordinates of the station are displayed (greyed out). Continue to the next screen to enter the Backsight Point ID.

Enter an existing Point ID for the Backsight to display the calculated direction and distance. Optionally enter the observed direction (to set 0° for example) and the measurements to the Backsight. When measurements are provided, the deltas will be displayed.

Setup Method: Known BS Point		
Station ID:	101	Set Az
Instr Height:	1.617m	
Northing:	5368970.195m	Known
Easting:	471985.914m	
Elevation:	18.737m	Reset
Description:	SPK	
<b>Existing Station ID</b>		Hlmrt
<input type="button" value="Edit"/>	<input type="button" value="Cancel"/>	<input type="button" value="Cont"/>

Known Backsight Point	
Backsight ID:	100
Calculated:	74°41'13" 93.617m
Azimuth	74°41'13"
Measure?	<input checked="" type="checkbox"/>
Slope Distance:	93.688m
Zenith Angle:	87°46'37"
Target Height:	1.300m
<b>Backsight Point ID</b>	
<input type="button" value="Edit"/>	<input type="button" value="Cancel"/> <input type="button" value="Set"/>

## Resection

**Resection** involves observing three or more known control points (angles only) to determine the coordinates of the Station. Least squares methods are applied when more than three control points are used. Zenith angles to one or more control points may be observed to determine the elevation of the station.

The example coordinates and directions below will be used to compute the coordinates of Point 569 (2D).

Pt#	Northing	Easting	Direction
570	3127.451	9030.360	180°00'02"
571	3213.971	8947.972	13°18'00"
572	3198.659	8967.350	84°29'40"
573	3189.142	8982.625	144°50'07"

Enter a new Point ID to be used to store the Station coordinates and enter the Instrument Height. Continue to the next screen to add the resection points.

Use the **Add** button on the Resection input screen to add observations to the resection points.

For each resection point; enter the Point ID and the direction to the point. Vertical angles are not observed for this example.

Setup Method: Resection

Station ID: 569

Instr Height: 1.713m

Set Az

Known

Resect

Hlmrt

New Station ID

Edit Cancel Cont

Resection

Point	Azimuth	Residual	Use
No Observations ...			

Add Cancel Cont

Add Resection Point 1/N

Point ID: 570

Azimuth: 180°00'02"

Vertical?

Zenith Angle: 90°00'00"

Target Height: 0.000m

Include vertical measurement?

√ Cancel OK

When all the observations are entered, the Resection input screen will display the directions and the computed residuals of each direction. The **Use -** button will toggle the inclusion of the selected point in the calculation.

Continue to the next screen when the residuals are satisfactory. The coordinates and standard deviations of the resection station are displayed.

The **Set** option on the menu will store the point in the project database and complete the setup.

Resection			
Point	Azimuth	Residual	Use
570	180°00'02"	+0°00'01"	Yes
571	13°18'00"	-0°00'01"	Yes
572	84°29'40"	+0°00'00"	Yes
573	144°50'07"	-0°00'01"	Yes

Buttons: Add, Delete, Edit, Use -, Cancel, Cont

Resection	
Northing:	3192.135m
Easting:	8962.250m
Elevation:	0.000m
Std Dev [N]:	0.000m
Std Dev [E]:	0.000m
Std Dev [Z]:	-

Buttons: Back, Set

NOTE: When completing a **Resection** setup; the first point observed will be set as the Backsight Point. The observed direction will be set as the Backsight Direction.

## Resection Helmert

**Resection Helmert** involves observing two or more control points (angles and distances) to compute the least squares best-fit coordinates of the Station.

The example coordinates, slope distances, directions and zenith angles below will be used to compute the coordinates of Point 568 (3D).

Pt#	Northing	Easting	Elevation	Distance	Direction	Zenith
570	3127.451	9030.360	396.190	94.016	180°00'02"	92°34'20"
571	3213.971	8947.972	399.345	26.112	13°18'00"	92°21'00"
572	3198.659	8967.350	398.600	8.474	84°29'40"	102°14'55"
573	3189.142	8982.625	398.610	20.672	144°50'07"	95°00'55"

Enter a new Point ID to be used to store the Station coordinates and enter the Instrument Height. Continue to the next screen to add the resection points.

Use the **Add** button on the Resection input screen to add observations to the resection points.

For each resection point; enter the Point ID, the distance, direction and zenith angle observation to the point. The same target height was used for all observations (1.300m).

**Setup Method: Resection Helmert**

Station ID:

Instr Height:

Set Az

Known

Resect

Hlmrt

Instrument Height

Edit

**Resection Helmert**

Point	Match	Hz	Dist
Add two or more pairs to calculate ...			

Add

**Add Resection Point 1/N**

Point ID:

Slope Distance:

Azimuth:

Zenith Angle:

Enter the Startin:

Match Type:

Target Height

Edit

When all the observations are entered, the Resection input screen will display the directions and the computed residuals of each direction. The **Use -** button will toggle the inclusion of the selected point in the calculation.

Continue to the next screen when the residuals are satisfactory. The coordinates and standard deviations of the resection station are displayed.

Resection Helmert		
Point	Match	Hz Dist
570	3D	0.007m
571	3D	0.002m
572	3D	0.003m
573	3D	0.002m

Buttons: Add, Delete, Edit, Cancel, Cont

Resection Helmert	
Northing:	3192.133m
Easting:	8962.252m
Elevation:	399.997m
Std Dev [N]:	0.003m
Std Dev [E]:	0.003m
Std Dev [Z]:	0.008m

Buttons: Sol, ΔXYZ, ΔPol, Back, Set

Residuals in coordinates (transformed measurements fit to control coordinates) and polar residuals are viewable through the **• ΔXYZ** and **• ΔPol** menu options.

Resection Helmert			
Point	ΔN	ΔE	ΔZ
570	-0.005m	0.004m	-0.001m
571	0.002m	-0.002m	0.006m
572	0.002m	-0.002m	-0.012m
573	0.002m	-0.001m	0.007m

Buttons: Sol, • ΔXYZ, ΔPol, Back, Set

Resection Helmert		
Point	Hz Dist	Azimuth
570	0.007m	139°36'42"
571	0.002m	313°30'04"
572	0.003m	315°37'34"
573	0.002m	332°07'27"

Buttons: Sol, ΔXYZ, • ΔPol, Back, Set

The **Set** option on the menu will store the point in the project database and complete the setup.

NOTE: When completing a **Resection Helmert** setup; the first point observed will be set as the Backsight Point. The observed direction will be set as the Backsight Direction.



## Measure

The **Measure** option In Traverse Plus 3D is used to calculate coordinates relative to the current Setup; by entering the measured angles and distances. Current settings will affect how information is entered; including:

1. **Zenith Angle** and **Target Height** fields are only available in **3D mode**.
2. **Azimuth** or **Angle Right** field depends on setting.
3. **Slope Distance** or **Horizontal Distance** field depends on setting. **Slope Distance** is only available in **3D mode**.
4. When storing the results, the coordinates of the solved position can either be displayed or automatically stored without displaying the coordinates.

Offsets may be applied to the measured values. Offsets are calculated perpendicular and parallel to the line of sight.

1. Offset values (positive or negative) can be input from the perspective of viewing either the **Instrument** or the **Target**.
2. Offset mode can be set to apply the current offsets to **Next Only** or **Permanent**.

When a point already exists with the same Point ID as the specified Point ID; the option to overwrite or to average the existing and new coordinates is presented.

## Stake

Staking calculations generally work by specifying the precise location to be guided towards. The precise location can be a point, a specific distance and offset relative to a line, curve or alignment, or it can be a slope away from a reference line.

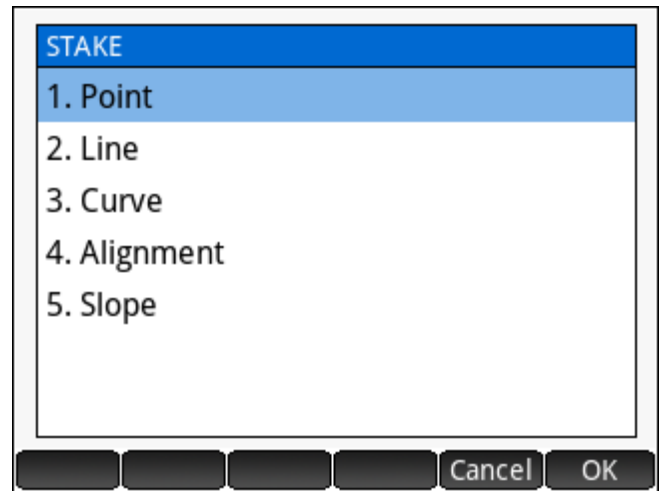

## Point

To stake a point; simply enter the Point ID to be staked. The horizontal distance and horizontal angle to the point are calculated and populated.

NOTE: The calculated distance is always horizontal, even if the current setting is set to use slope distances.

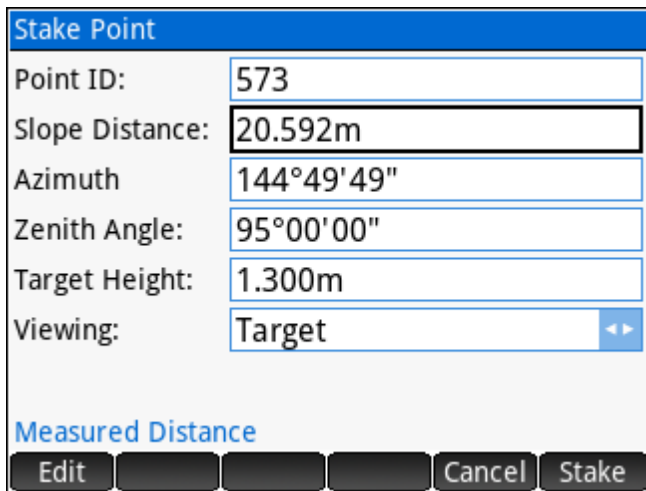

Stake Point	
Point ID:	573
Slope Distance:	20.592m
Azimuth	144°49'49"
Zenith Angle:	95°00'00"
Target Height:	1.300m
Viewing:	Target
Measured Distance	
Edit	Cancel Stake

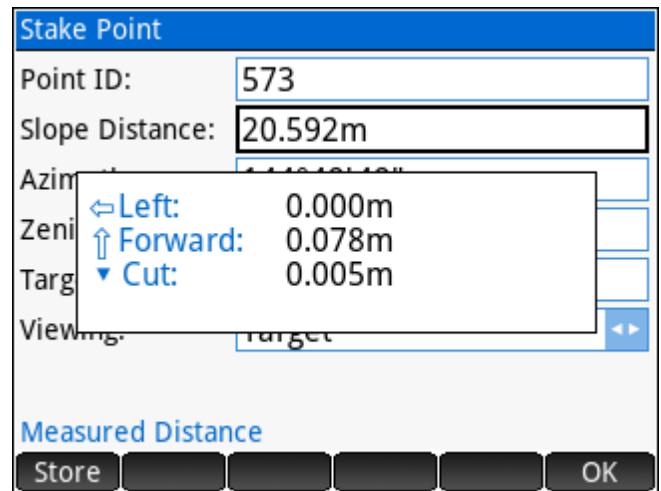

Stake Point	
Point ID:	573
Slope Distance:	20.592m
Azimuth	144°49'49"
Zenith Angle:	95°00'00"
Target Height:	1.300m
Viewing:	target
Measured Distance	
Store	OK

← Left: 0.000m  
↑ Forward: 0.078m  
↓ Cut: 0.005m

When the measured values are entered, use the **Stake** button on the menu to calculate and display the staking directions. The staking directions are displayed as per the selected option: **Viewing Target**, **Viewing Instrument**, or **Cardinal**.

The **Store** button on the results menu can be used to store the coordinates of the measured position.

## Line

To stake a line, first define the line. Two points are used to define the line, the order of which are important when specifying offsets.

The Start Station specifies the station at the first point of the baseline.

On the main input screen; enter the station to stake and the offset from the line.

When the measured values are entered, use the

**Stake** button on the menu to calculate and display

the staking directions. The staking directions are displayed as per the selected option: *Viewing Target*, *Viewing Instrument*, or *Cardinal*.

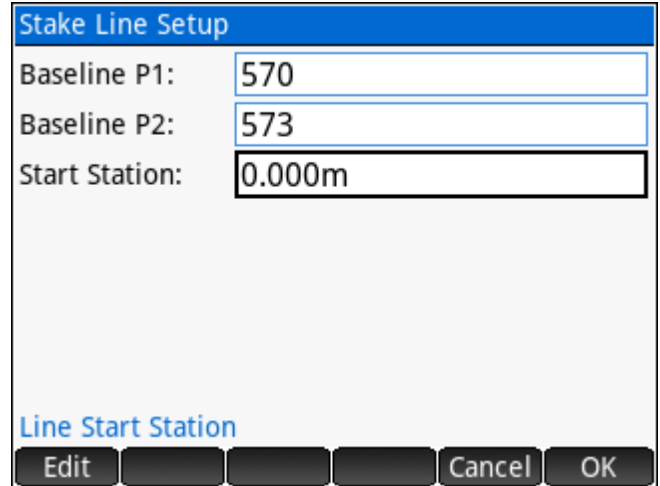

The Stake Line Setup screen displays the following fields:

Baseline P1:	570
Baseline P2:	573
Start Station:	0.000m

Below the fields is a blue link labeled "Line Start Station" and a row of buttons: Edit, [blank], [blank], [blank], Cancel, and OK.

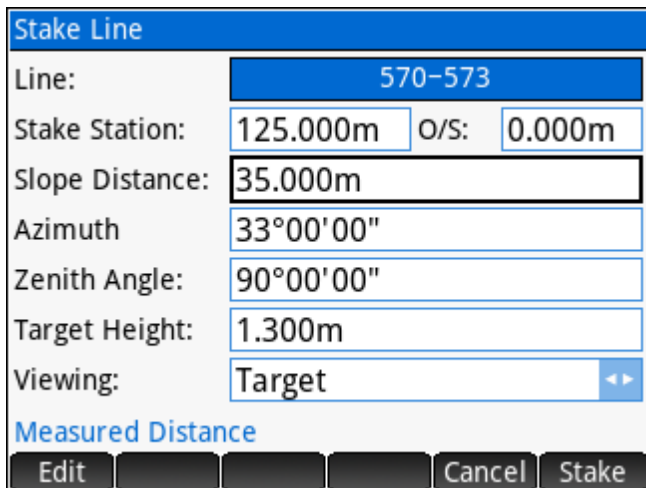

The Stake Line screen displays the following fields:

Line:	570-573	
Stake Station:	125.000m	O/S: 0.000m
Slope Distance:	35.000m	
Azimuth	33°00'00"	
Zenith Angle:	90°00'00"	
Target Height:	1.300m	
Viewing:	Target	

Below the fields is a blue link labeled "Measured Distance" and a row of buttons: Edit, [blank], [blank], [blank], Cancel, and Stake.

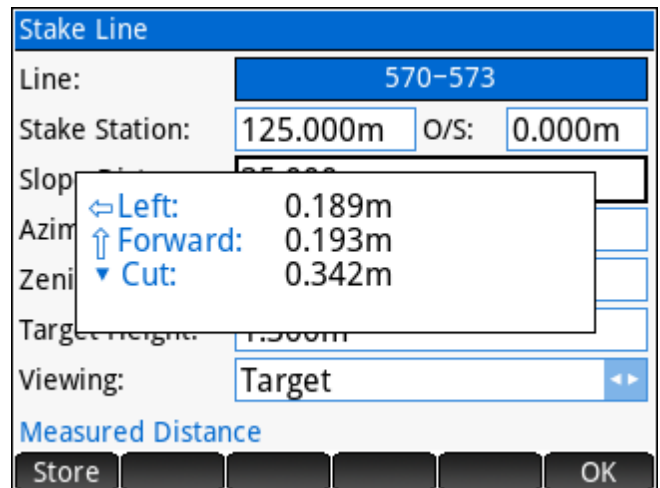

The Stake Line screen displays the following fields:

Line:	570-573	
Stake Station:	125.000m	O/S: 0.000m
Slope Distance:	35.000m	
Azimuth	33°00'00"	
Zenith Angle:	90°00'00"	
Target Height:	1.300m	
Viewing:	Target	

A pop-up window displays the following staking directions:

Left:	0.189m
Forward:	0.193m
Cut:	0.342m

Below the fields is a blue link labeled "Measured Distance" and a row of buttons: Store, [blank], [blank], [blank], [blank], and OK.

The **Store** button on the results menu can be used to store the coordinates of the measured position.

## Curve

To stake a curve, first define the curve. The beginning of curve, radial point, and end of curve points are required to define the curve. The direction of curve is important for both stationing and offsets.

The Start Station specifies the station at the beginning of curve point.

On the main input screen; enter the station to stake and the offset from the curve.

When the measured values are entered, use the

**Stake** button on the menu to calculate and display the staking directions. The staking directions are displayed as per the selected option: *Viewing Target*, *Viewing Instrument*, or *Cardinal*.

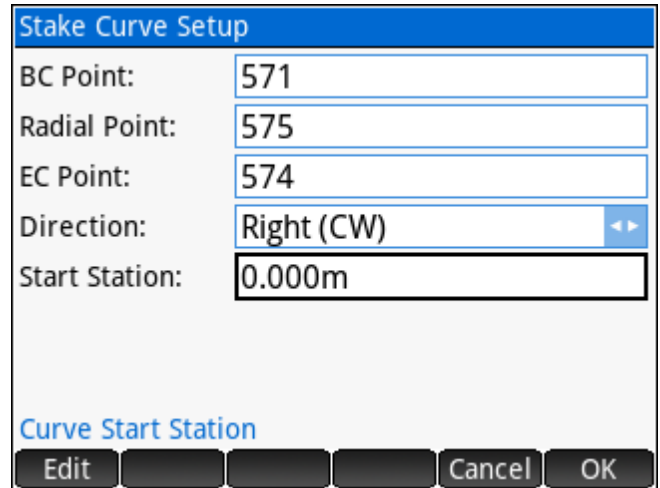

Stake Curve Setup

BC Point:	571
Radial Point:	575
EC Point:	574
Direction:	Right (CW) <>
Start Station:	0.000m

Curve Start Station

Edit [ ] [ ] [ ] Cancel OK

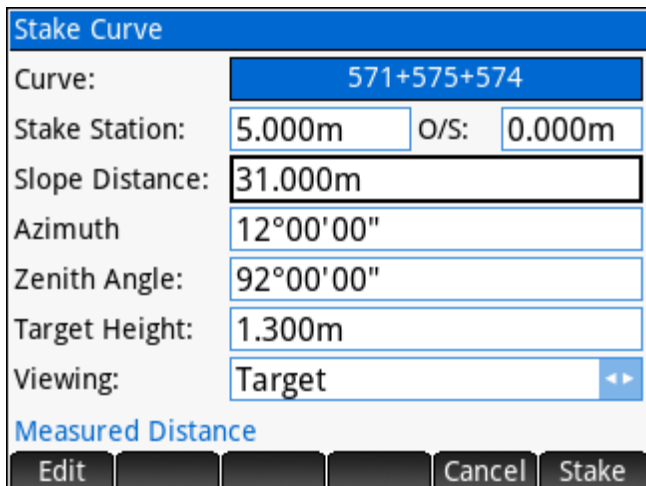

Stake Curve

Curve:	571+575+574	
Stake Station:	5.000m	O/S: 0.000m
Slope Distance:	31.000m	
Azimuth	12°00'00"	
Zenith Angle:	92°00'00"	
Target Height:	1.300m	
Viewing:	Target <>	

Measured Distance

Edit [ ] [ ] [ ] Cancel Stake

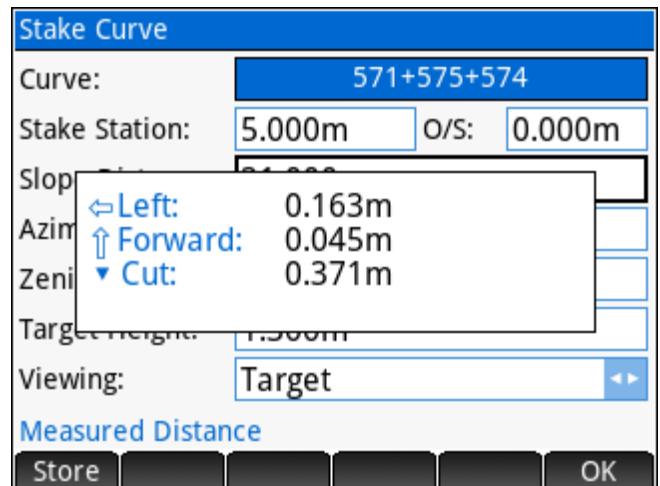

Stake Curve

Curve:	571+575+574	
Stake Station:	5.000m	O/S: 0.000m
Slope Distance:	31.000m	
Azimuth	12°00'00"	
Zenith Angle:	92°00'00"	
Target Height:	1.300m	
Viewing:	Target <>	

Measured Distance

Store [ ] [ ] [ ] OK

Left: 0.163m  
Forward: 0.045m  
Cut: 0.371m

The **Store** button on the results menu can be used to store the coordinates of the measured position.

## Alignment

To stake any station and offset along an alignment; the alignment must already be created.

On the main input screen; select the alignment to use, then enter the station and offset to stake.

When the measured values are entered, use the **Stake** button on the menu to calculate and display the staking directions. The staking directions are displayed as per the selected option: *Viewing Target*, *Viewing Instrument*, or *Cardinal*.

Stake Alignment	
Alignment:	SAMPLE
Stake Station:	0+125.000 O/S: 0.000m
Slope Distance:	31.500m
Azimuth	12°00'00"
Zenith Angle:	85°00'00"
Target Height:	1.300m
Viewing:	Target
Measured Distance	
Edit	Cancel Stake

Stake Alignment	
Alignment:	SAMPLE
Stake Station:	0+125.000 O/S: 0.000m
Slope Distance:	31.500m
Azimuth	12°00'00"
Zenith Angle:	85°00'00"
Target Height:	1.300m
Viewing:	Target
Measured Distance	
Store	OK

⇒ Right: 0.094m  
↑ Forward: 0.207m  
▲ Fill: 5.535m

The **Store** button on the results menu can be used to store the coordinates of the measured position.

## Slope

To stake a slope, first define the line from which the slope calculations will be determined. Two points are used to define the line, the order of which are important when specifying offsets and slope.

The Start Station specifies the station at the first point of the baseline.

On the main input screen; enter the slope to stake.

When the measured values are entered, use the

**Stake** button on the menu to calculate and display

the cut/fill amounts. The station and offset relative to the line are also displayed.

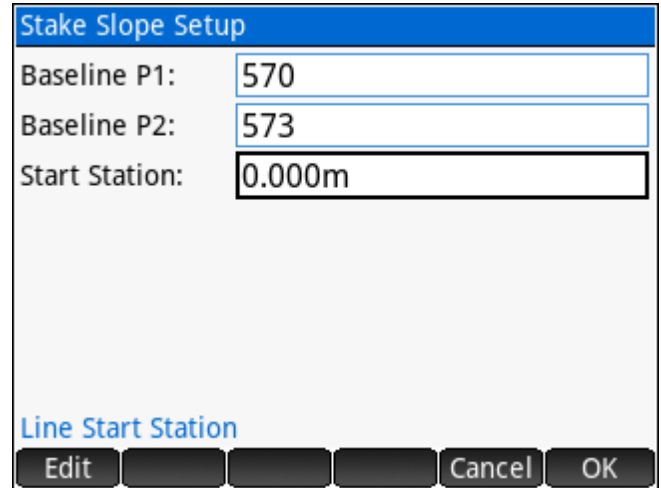

Stake Slope Setup

Baseline P1:	570
Baseline P2:	573
Start Station:	0.000m

Line Start Station

Edit [ ] [ ] [ ] [ ] Cancel OK

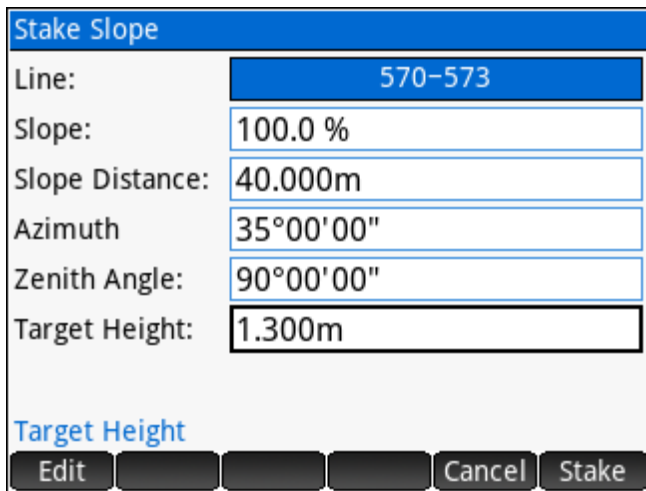

Stake Slope

Line:	570-573
Slope:	100.0 %
Slope Distance:	40.000m
Azimuth	35°00'00"
Zenith Angle:	90°00'00"
Target Height:	1.300m

Target Height

Edit [ ] [ ] [ ] [ ] Cancel Stake

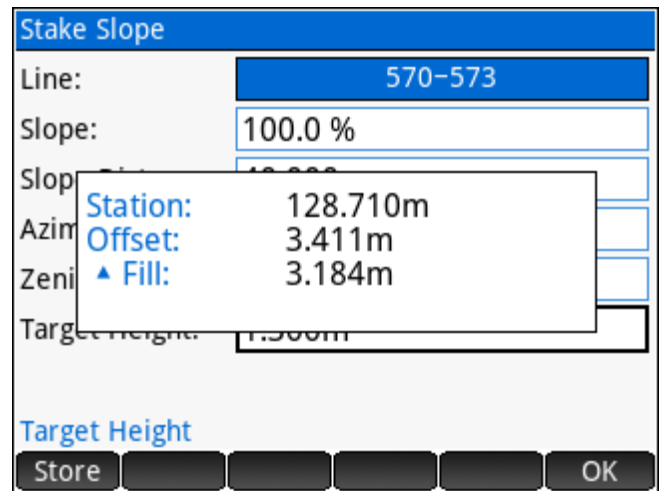

Stake Slope

Line:	570-573
Slope:	100.0 %
Slope Distance:	40.000m
Azimuth	35°00'00"
Zenith Angle:	90°00'00"
Target Height:	1.300m

Station: 128.710m  
Offset: 3.411m  
▲ Fill: 3.184m

Target Height

Store [ ] [ ] [ ] [ ] OK

The **Store** button on the results menu can be used to store the coordinates of the measured position.

## Reference

Reference calculations generally work by specifying a reference geometry, and then obtaining information to report the measured position relative to the geometry. The reference geometry can be a line, curve or alignment.

## Line

To measure relative to a reference line, first define the line. Two points are used to define the line, the order of which are important to determine offsets.

The Start Station specifies the station at the first point of the baseline.

When the measured values are entered, use the **Check** button on the menu to calculate and display the position relative to the line. The forward/back distances are on the current line of sight to intersect the reference geometry, and are displayed as per the selected option: *Viewing Target*, or *Viewing*

## Instrument.

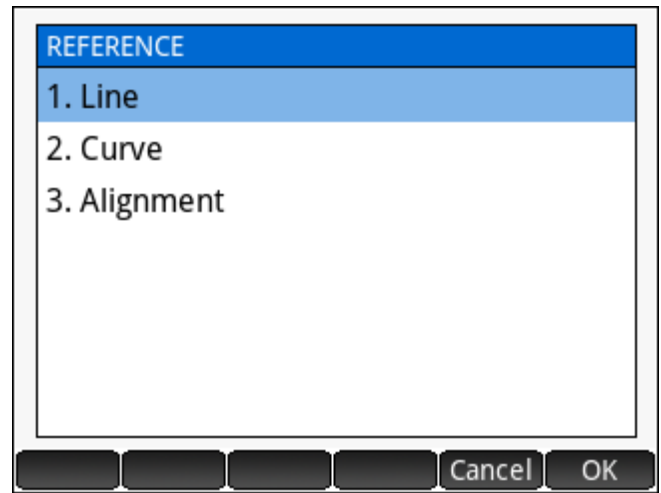

A screenshot of the 'REFERENCE' menu. The menu is titled 'REFERENCE' and contains three options: '1. Line', '2. Curve', and '3. Alignment'. The '1. Line' option is currently selected and highlighted in blue. At the bottom of the menu, there are several buttons, including 'Cancel' and 'OK'.

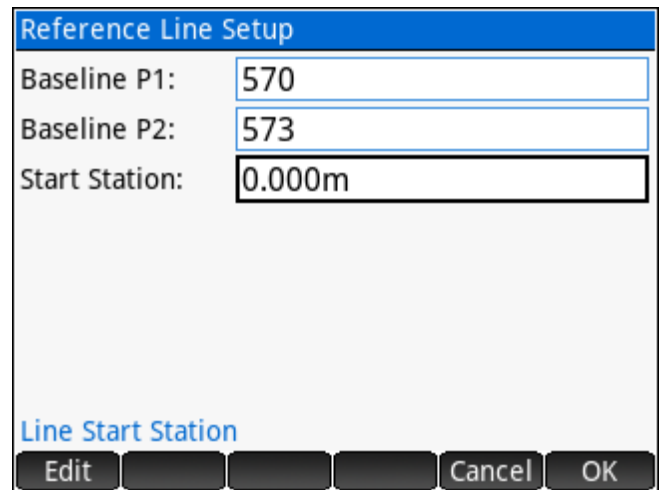

A screenshot of the 'Reference Line Setup' dialog box. The dialog has a title bar 'Reference Line Setup'. It contains three input fields: 'Baseline P1:' with the value '570', 'Baseline P2:' with the value '573', and 'Start Station:' with the value '0.000m'. Below the input fields, there is a link 'Line Start Station'. At the bottom, there are buttons for 'Edit', 'Cancel', and 'OK'.

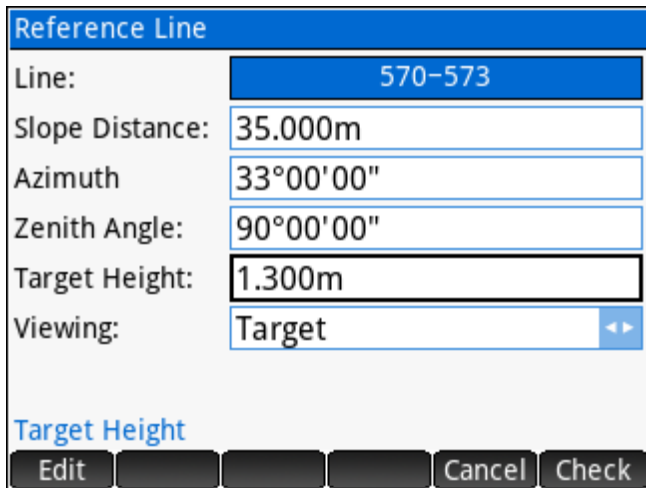

A screenshot of the 'Reference Line' dialog box. The dialog has a title bar 'Reference Line'. It contains several input fields: 'Line:' with the value '570-573', 'Slope Distance:' with the value '35.000m', 'Azimuth' with the value '33°00'00"', 'Zenith Angle:' with the value '90°00'00"', 'Target Height:' with the value '1.300m', and 'Viewing:' with a dropdown menu set to 'Target'. Below the input fields, there is a link 'Target Height'. At the bottom, there are buttons for 'Edit', 'Cancel', and 'Check'.

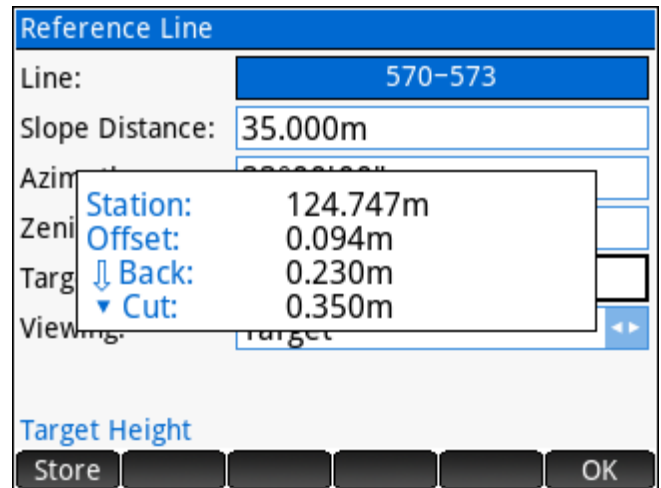

A screenshot of the 'Reference Line' dialog box with a results popup window. The dialog box is the same as in the previous screenshot. The results popup window is titled 'Station:' and contains the following information: 'Station: 124.747m', 'Offset: 0.094m', '↓ Back: 0.230m', and '▼ Cut: 0.350m'. At the bottom of the dialog, there are buttons for 'Store' and 'OK'.

The **Store** button on the results menu can be used to store the coordinates of the measured position.

## Curve

To measure relative to a reference curve, first define the curve. The beginning of curve, radial point, and end of curve points are required to define the curve. The direction of curve is important for both stationing and offsets.

The Start Station specifies the station at the beginning of curve point.

When the measured values are entered, use the

**Check** button on the menu to calculate and display

the position relative to the curve. The forward/back distances are on the current line of sight to intersect the reference geometry, and are displayed as per the selected option: *Viewing Target*, or *Viewing Instrument*.

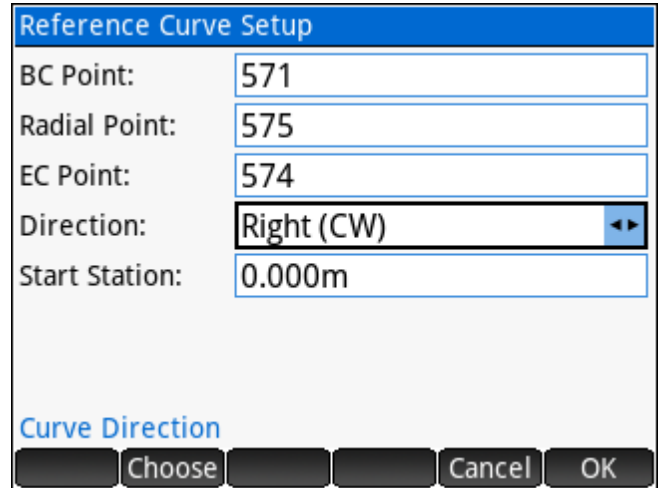

Reference Curve Setup

BC Point:	571
Radial Point:	575
EC Point:	574
Direction:	Right (CW)
Start Station:	0.000m

Curve Direction

Choose Cancel OK

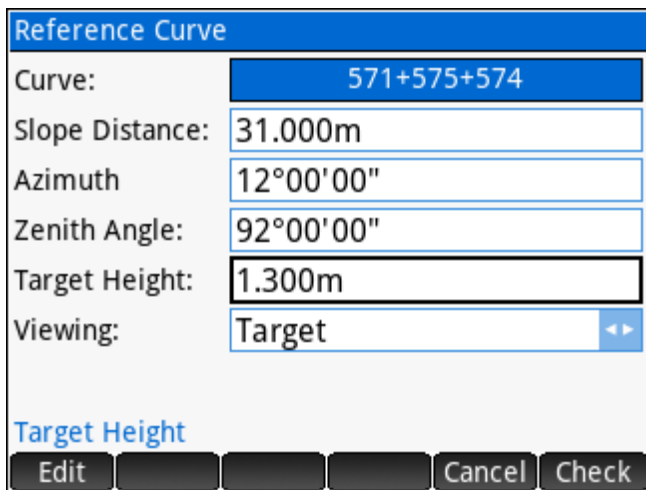

Reference Curve

Curve:	571+575+574
Slope Distance:	31.000m
Azimuth:	12°00'00"
Zenith Angle:	92°00'00"
Target Height:	1.300m
Viewing:	Target

Target Height

Edit Cancel Check

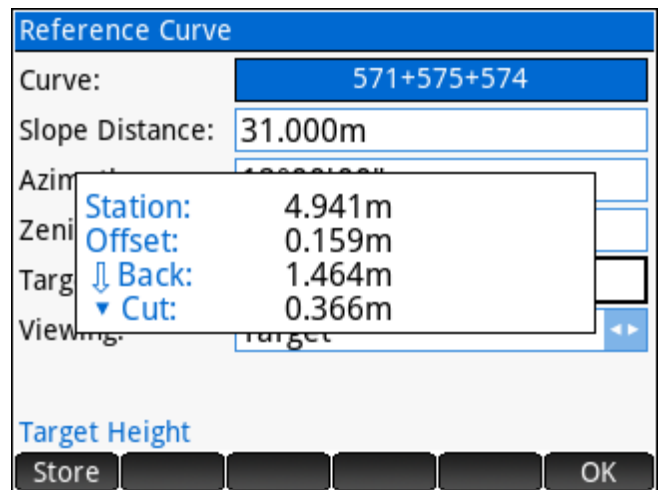

Reference Curve

Curve:	571+575+574
Slope Distance:	31.000m
Azimuth:	12°00'00"
Zenith Angle:	92°00'00"
Target Height:	1.300m
Viewing:	Target

Target Height

Station: 4.941m  
Offset: 0.159m  
↓ Back: 1.464m  
▼ Cut: 0.366m

Store OK

The **Store** button on the results menu can be used to store the coordinates of the measured position.



## Alignment

To measure relative to an alignment; the alignment must already be created.

On the main input screen; select the alignment to use, then enter the station and offset to stake.

When the measured values are entered, use the **Check** button on the menu to calculate and display the position relative to the alignment.

Reference Alignment	
Alignment:	SAMPLE
Slope Distance:	31.500m
Azimuth	12°00'00"
Zenith Angle:	85°00'00"
Target Height:	1.300m

Target Height

Edit [ ] [ ] [ ] [ ] Cancel Check

Reference Alignment	
Alignment:	SAMPLE
Slope Distance:	31.500m
Azimuth	12°00'00"
Zenith Angle:	85°00'00"
Target Height:	1.300m

Target Height

Station: 0+124.796  
Offset: -0.099m  
▲ Fill: 5.516m

Store [ ] [ ] [ ] [ ] OK

The **Store** button on the results menu can be used to store the coordinates of the measured position.

## Tools

**Traverse Plus 3D** tools are necessary or handy utilities that are related to the measurement data. Additional tools will be added in a future release.

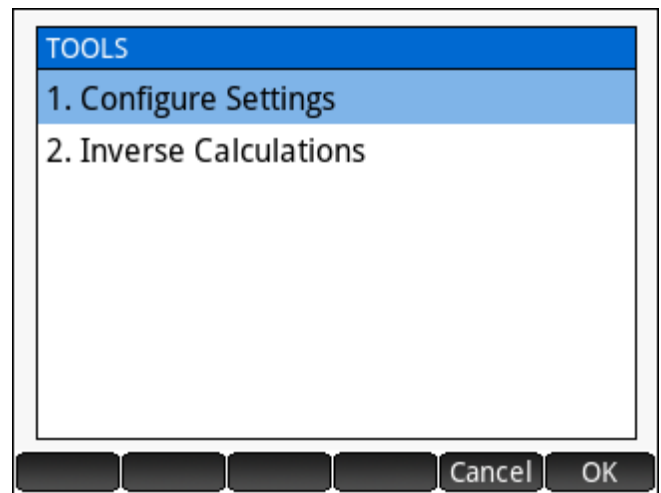

### Configure Settings

Settings make it possible to add flexibility to how **Traverse Plus 3D** operates.

- ▶ Mode – **2D** mode disables zenith angle and target height fields for measurements, and requires horizontal distance measurements. **3D** mode enables all fields and allows a choice of entering horizontal or slope distances.
- ▶ Horizontal Angles – Set true **Azimuth** or **Angle Right** input for horizontal angles.
- ▶ Distances – Set **Slope** or **Horizontal** input for distances. 2D mode only supports horizontal.
- ▶ Coordinates – Within the **Measure** application this setting determines if the coordinates of the measured point are displayed prior to storing the point.

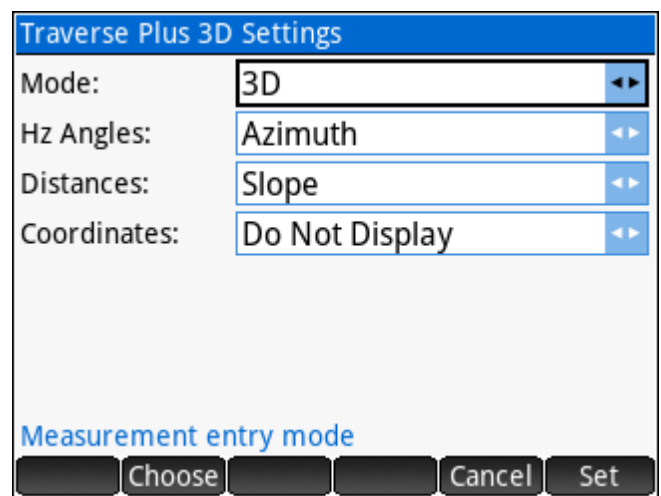

### Inverse Calculations

Opens the [Inverse Calculations](#) options to eliminate the need to exit **Traverse Plus 3D** to calculate inverses.

### **Close**

Closes **Traverse Plus 3D** and returns to the main menu.

## 8.4 Coordinate Converter

The Coordinate Converter includes the following coordinate conversion capabilities:

1. [Grid↔Geodetic↔Cartesian](#) – Convert between grid coordinates, geodetic coordinates, and cartesian coordinates.
2. [Grid1→Grid2 \(Single Point\)](#) – Convert a coordinate position from one grid projection to another. Input can be grid, geodetic, or cartesian coordinates.
3. [Grid1→Grid2 \(Convert Database\)](#) – Convert points in the project database from one grid projection to another.
4. [Grid↔Ground \(Single Point\)](#) – Convert coordinates of a single point between grid and ground based on supplied parameters.
5. [Grid↔Ground \(Convert Database\)](#) – Convert points in the database between grid and ground based on supplied parameters.

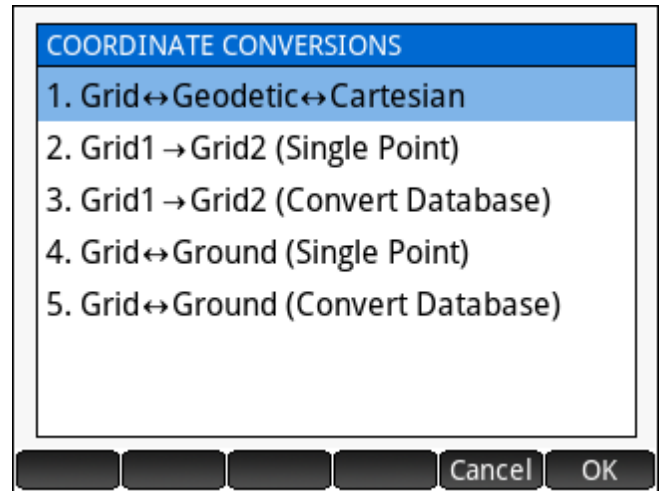

### Grid↔Geodetic↔Cartesian

Convert between grid coordinates, geodetic coordinates, and cartesian coordinates using the current [Coordinate System](#) settings. Input can be grid coordinates (N,E,h), geodetic coordinates ( $\Phi,\lambda,h$ ), cartesian coordinates (x,y,z), or grid coordinates from a point in the database.

Results include all three coordinate representations, the point grid/elevation/combined factors, and the grid convergence angle at the point.

Convert from Grid		
Northing:	<input type="text" value="5527840.5900m"/>	N,E,h
Easting:	<input type="text" value="325213.2010m"/>	
Ell.Height:	<input type="text" value="355.0130m"/>	$\Phi,\lambda,h$
Coord Sys:	UTM Zone 11	x,y,z
Ellipsoid:	GRS80	
Northing Coordinate		Point
<input type="button" value="Edit"/> <input type="button" value="Cancel"/> <input type="button" value="Calc"/>		

Coordinate Conversion Results	
Northing:	5527840.5690m
Easting:	325213.2010m
Ell.Height:	355.0130m
Grid Factor:	0.99997522
Elev Factor:	0.99994437
Combined:	0.99991959
Convergence:	-1°51'38.74739"
Latitude:	N49°52'38.72591"
Longitude:	W119°25'58.13532"
x:	-2023855.3960m
y:	-3586959.6227m
z:	4854285.6476m
<input type="button" value="Store"/> <input type="button" value="COPY"/> <input type="button" value="OK"/>	

## Grid1→Grid2 (Single Point)

Convert a coordinate position from one grid projection to another. Both grid projections, the transformation method and the transformations parameters are selected prior to calculation. Available transformation methods include:

- ▶ **No Transformation** – Generally if both grid projections are based on the same ellipsoid, then no transformation is required.
- ▶ **Dual Step (via WGS84)** – When an intermediate reference frame is required to convert to and from. Frequently the transformation parameters are known to convert to WGS84, in this case the user **MUST** define the transformation parameters for both **Transform 1** and **Transform 2** to be **TOWGS84**. The first step transforms to WGS84 with the supplied parameters directly, the second step transforms from WGS84 by changing the signs of the transformation parameters. This is done to eliminate the need to have two sets of transformation parameters for typical use. See the [Transformation Parameters](#) section for more information.
- ▶ **Single Step (Direct)** – When the transformation parameters to convert directly from one reference frame to another are known.

Input can be grid coordinates (N,E,h), or grid coordinates from a point in the database. The vertical system from the [Coordinate System](#) settings is used for height entry. See elevations note next page.

The results include the position of the point in the second projection, the point grid/elevation/combined factors, the grid convergence angle at the point, and the geodetic coordinates of the point.

NOTE: When using transformations to transform points between projections based on different ellipsoids, the [Vertical System](#) should be set to *Ellipsoidal* to obtain meaningful height results.

### Grid1→Grid2 (Convert Database)

Convert points in the project database from one grid projection to another. Both grid projections, the transformation method and the transformations parameters are selected prior to calculation. See [previous section](#) for more information on available transformation methods.

Next, enter the point range to convert the coordinates in the database and specify how to store the new coordinates.

### Transformation Parameters

A default **NULL** transformation is included, it does nothing but can be useful in some cases. All other transformations can be defined as 3 or 7 parameter transformations. The menu can be used to create new transformations and edit or delete existing ones. Other types of transformations:

- ▶ **Bursa/Wolf** – Use the 7 Parameter in lieu of.
- ▶ **4 Parameter** – Use the 7 Parameter and set the 3 rotations to zero.
- ▶ **6 Parameter** – Use the 7 Parameter and set the scale parameter to zero.
- ▶ **Molodensky** – Use the 3 Parameter in lieu of.

Name	Type
NULL	None

## Grid↔Ground (Single Point)

Land surveyors will often work with “ground-level” coordinates to eliminate the need to correct for a scale factor for distance/area/volume calculations; but for various reasons they also require the “geo-referenced” grid positions of their coordinates for other purposes. The grid/ground conversion tool is created to make the conversion from one to the other a simple task for any/all points in a project.

The parameters are defined and stored separately for each project and include:

1. A base point from which any scaling and rotation is done. This can be set to the coordinate system origin 0,0,0.
2. The base point horizontal coordinates in the converted system (ground or grid). This can often be a common point with the same coordinates in both grid and ground, in which case the **Use Base** option applies. The shift is calculated between the base point and the given coordinates.
3. The base point elevation in the converted system (ground or grid). The shift is calculated between the base point and the given elevation.
4. The scale factor to scale the horizontal coordinates from the base point.
5. The scaling method, either multiply or divide by the given scale factor.
6. The rotation angle to rotate from the base point.

When the parameters are defined; enter any point number in the database to convert.

Base Point:	501	0,0,0?	<input type="checkbox"/>
Base N:	0.000m	Use Base?	<input checked="" type="checkbox"/>
Base E:	0.000m		
Base Z:	0.000m	Use Base?	<input checked="" type="checkbox"/>
Scale Factor:	0.9999123000		
Scaling:	Multiply by Factor		
Rotation:	+0°00'00"		
Choose Scaling Method			
	Choose	Cancel	Cont

Convert Point	
Point:	553
Enter Point ID to convert	
Edit	Cancel
Calc	

Convert Point	
Point:	553
North:	5497414.571m
East:	689497.264m
Elev:	963.514m
Enter Point ID to convert	
Store	OK

## Grid↔Ground (Convert Database)

Convert multiple points in the database between grid and ground based on supplied parameters. See the [previous section](#) for information about the conversion parameters.

When the parameters are defined; enter the point range to convert the coordinates in the database and specify how to store the new coordinates.

Convert Database

Point(s):

All Points:

Calc Points: **Overwrite**

Additive #:

Description:  Original?

Enter Point(s) to Convert (#..#,#, #..#)

Edit    Cancel Calc

## 8.5 Ellipsoid Calculations

DIRECT and INVERSE Computations on the ellipsoid are implemented using Vincenty's equations.

Position input for both types of calculations can be grid coordinates (N,E,h), geodetic coordinates ( $\Phi,\lambda,h$ ), cartesian coordinates (x,y,z), or grid coordinates from a point in the database.

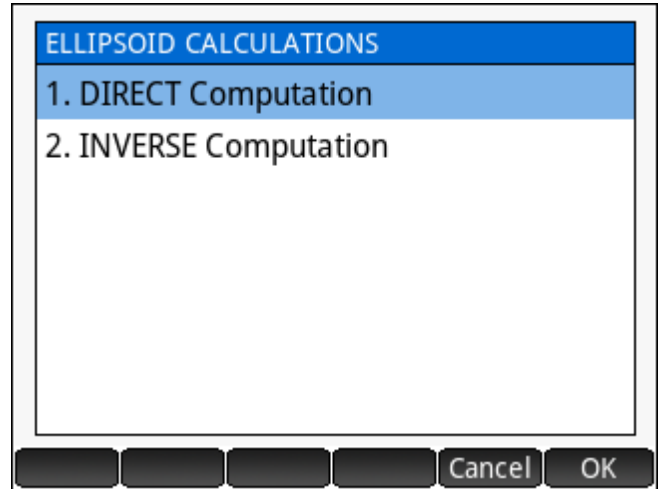

### DIRECT Computation

Enter the position of the first point in any of the available formats and provide the forward azimuth and ellipsoidal distance to the second point.

The solution shows:

- ▶ The grid coordinates of the second point, the grid direction and grid distance to the second point
- ▶ The geodetic coordinates of the second point and the back azimuth.
- ▶ The cartesian coordinates of the second point.

Direct from Geodetic		
Latitude 1:	N49°52'38.72591"	N,E
Longitude 1:	W119°25'58.13532"	
Forward Az:	59°00'55.57"	$\Phi,\lambda$
Ellipsoid Dist:	477.395m	
Ellipsoid:	GRS80	x,y,z
Latitude 1 (+North, -South)		Point
<input type="button" value="Edit"/> <input type="button" value="Cancel"/> <input type="button" value="Calc"/>		

DIRECT Computation Results	
Northing 2:	5528072.9105m
Easting 2:	325630.2282m
Grid Direc:	60°52'34.37"
Grid Dist (2D):	477.383m
Latitude 2:	N49°52'46.67996"
Longitude 2:	W119°25'37.63595"
Back Azimuth:	239°01'11.25"
x2:	-2023294.1689m
y2:	-3586797.8055m
z2:	4854172.5450m
<input type="button" value="Store"/> <input type="button" value="COPY"/> <input type="button" value="OK"/>	



## INVERSE Computation

Enter the positions of two points in any of the available formats

The solution shows:

- ▶ The grid direction, grid distance, the average combined factor and the ground distance between the two points.
- ▶ The ellipsoid distance, the forward and back azimuths between the two points.
- ▶ The cartesian deltas, and the 3D point to point vector length.

Inverse from Geodetic		
Latitude 1:	N49°52'38.72591"	N,E,h
Longitude 1:	W119°25'58.13532"	
Ell.Height 1:	355.0130m	Φ,λ,h
Latitude 2:	N49°52'46.67995"	
Longitude 2:	W119°25'37.63596"	x,y,z
Ell.Height 2:	359.8570m	
Ellipsoid:	GRS80	Points
Ellipsoid Height 1		
Edit		Cancel Calc

INVERSE Computation Results	
Grid Direc:	60°52'34.43"
Grid Dist (2D):	477.382m
Avg Combined:	0.99991832
Ground (2D):	477.421m
Ellipsoid Dist:	477.394m
Forward Az:	59°00'55.58"
t-T Correction:	+0°00'00.10"
Back Azimuth:	239°01'11.26"
t-T Correction:	-0°00'15.57"
dx:	447.295m
dy:	-40.155m
dz:	162.077m
Length (3D):	477.446m
COPY OK	

# Appendix A

The table below includes the parameters used for the ellipsoid definitions in **SGS Prime COGO**.

$$b = a \times (1 - f)$$

$$e' = \sqrt{\frac{a^2 - b^2}{a^2}}$$

$$f = (a - b) \div a$$

$$e'' = \sqrt{\frac{a^2 - b^2}{b^2}}$$

Reference Ellipsoid	Defining and Calculated Parameters	
Clarke 1866 (NAD27)	<b>a = 6378206.4</b> f = 0.00339007530392879	<b>b = 6356583.8</b> 1/f = 294.978698213898
GRS80 (NAD83)	<b>a = 6378137</b> f = 0.00335281068118232	b = 6356752.31414036 <b>1/f = 298.257222101</b>
WGS84	<b>a = 6378137</b> f = 0.00335281066474748	b = 6356752.31424518 <b>1/f = 298.257223563</b>
International 1924 (Hayford)	<b>a = 6378388</b> f = 0.00336700336700337	b = 6356911.94612795 <b>1/f = 297</b>
Clarke 1880 (ARC)	<b>a = 6378249.145</b> f = 0.00340754619444173	b = 6356514.96639875 <b>1/f = 293.4663077</b>
Clarke 1880 (IGN)	<b>a = 6378249.2</b> f = 0.00340754952001565	<b>b = 6356515</b> 1/f = 293.466021293627
Clarke 1880 (RGS)	<b>a = 6378249.145</b> f = 0.00340756137869933	b = 6356514.86954978 <b>1/f = 293.465</b>
Airy 1830	<b>a = 6377563.396</b> f = 0.00334085064149708	b = 6356256.90923729 <b>1/f = 299.3249646</b>
Airy 1830 (Modified)	<b>a = 6377340.189</b> f = 0.00334085071675583	b = 6356034.44745858 <b>1/f = 299.3249575</b>
Australian National Spheroid	<b>a = 6378160</b> f = 0.00335289186923722	b = 6356774.71919531 <b>1/f = 298.25</b>
Krassovsky 1940	<b>a = 6378245</b> f = 0.00335232986925913	b = 6356863.01877305 <b>1/f = 298.3</b>
Bessel 1841	<b>a = 6377397.155</b> f = 0.00334277308160762	b = 6356078.96345955 <b>1/f = 299.1528218</b>
Parametry Zemli 1990 (PZ-90)	<b>a = 6378136</b> f = 0.00335281317789691	b = 6356751.30156878 <b>1/f = 298.257</b>